

Technical Reference



TDS6604B & TDS6804B Digital Storage Oscilloscopes Specifications and Performance Verification

071-1502-02

Warning

The servicing instructions are for use by qualified personnel only. To avoid personal injury, do not perform any servicing unless you are qualified to do so. Refer to all safety summaries prior to performing service.

www.tektronix.com



071150202

Copyright © Tektronix, Inc. All rights reserved.

Tektronix products are covered by U.S. and foreign patents, issued and pending. Information in this publication supercedes that in all previously published material. Specifications and price change privileges reserved.

Tektronix, Inc., P.O. Box 500, Beaverton, OR 97077

TEKTRONIX and TEK are registered trademarks of Tektronix, Inc.

Table of Contents

Specifications	1-1
Product and Feature Description	1-1
Acquisition Features	1-2
Signal Processing Features	1-2
Display Features	1-2
Measurement Features	1-3
Trigger Features	1-3
Convenience Features	1-3
Specification Tables	1-4
Performance Verification	2-1
Conventions	2-2
Brief Procedures	3-1
Self Tests	3-1
Verify Internal Adjustment, Self Compensation, and Diagnostics	3-1
Functional Tests	3-2
Verify All Input Channels	3-3
Verify the Time Base	3-6
Verify the A (Main) and B (Delayed) Trigger Systems	3-8
Performance Tests	4-1
Prerequisites	4-1
Equipment Required	4-2
TDS6000B Test Record	4-4
Signal Acquisition System Checks	4-13
Check DC Voltage Measurement Accuracy	4-13
Check Offset Accuracy	4-17
Check Maximum Input Voltage	4-21
Check Analog Bandwidth	4-25
Check Delay Between Channels	4-29
Check Channel Isolation (Crosstalk)	4-33
Check Input Impedance	4-38
Time Base System Checks	4-40
Check Long-Term Sample Rate and Delay Time Accuracy and Reference	4-40
Check Delta Time Measurement Accuracy	4-44
Trigger System Checks	4-47
Check Time Accuracy for Pulse, Glitch, Timeout, and Width Triggering .	4-47
Check Sensitivity, Edge Trigger, DC Coupled	4-50
Output Signal Checks	4-55
Check Outputs — CH 3 Signal Out and Aux Trigger Out	4-56
Check Probe Compensation Output	4-58
Serial Trigger Checks (Option ST Only)	4-62
Check Serial Trigger Baud Rate Limits and Word Recognizer Position Accuracy	4-62
Check Serial Trigger Clock Recovery Range	4-69
Sine Wave Generator Leveling Procedure	4-73

Specifications

This chapter contains the specifications for the TDS6000B Series. All specifications are guaranteed unless labeled “typical.” Typical specifications are provided for your convenience but are not guaranteed. Specifications that are marked with the ✓ symbol are checked in the *Performance Tests* section. Unless noted otherwise, all specifications apply to all TDS6000B Series oscilloscopes.

To meet specifications, the following conditions must be met:

- The oscilloscope must have been calibrated in an ambient temperature between 20 °C and 30 °C (68 °F and 86 °F).
- The oscilloscope must be operating within the environmental limits listed in Table 1-11, page 1-17.
- The oscilloscope must be powered from a source that meets the specifications listed in Table 1-9, page 1-15.
- The oscilloscope must have been operating continuously for at least 20 minutes within the specified operating temperature range.
- You must perform the Signal Path Compensation procedure after the 20-minute warm-up period, and the ambient temperature must not change more than 5 °C (9 °F) without first repeating the procedure. See page 3-2 for instructions to perform this procedure.

Product and Feature Description

Your TDS6000B Series is shown in Table 1-1.

Table 1-1: TDS6000B Series

Model	Number of channels	Bandwidth	Maximum sample rate (real time)
TDS6604B	4	6 GHz	20 GS/s
TDS6804B	4	8 GHz	20 GS/s

Acquisition Features

Separate Digitizers. Ensure accurate timing measurements with separate digitizers for each channel. Acquisition on multiple channels is always concurrent. The digitizers can also be combined to yield a higher sample rate on a single channel.

Long Record Lengths. Maximum record length up to 32,000,000 points simultaneously on all four channels.

Peak Detect Acquisition Mode. See pulses as narrow as 50 ps even at the slower time base settings. Captures narrow glitches at all real-time sampling rates.

Acquisition Control. Acquire continuously or set up to capture single shot acquisitions. Enable or disable optional acquisition features such as equivalent time.

Horizontal Delay. Use delay when you want to acquire a signal at a significant time interval after the trigger point. Toggle delay on and off to quickly compare the signal at two different points in time.

Signal Processing Features

Average, Envelope, and Hi Res Acquisition. Use Average acquisition mode to remove uncorrelated noise from your signal. Use Envelope to capture and display the maximum variation of the signal. Use Hi Res to increase vertical resolution for lower bandwidth signals.

Waveform Math. Set up simple math waveforms using the basic arithmetic functions or create more advanced math waveforms using the math expression editor. Waveform expressions can even contain measurement results and other math waveforms.

Spectral Analysis. Display spectral magnitude and phase waveforms based on your time-domain acquisitions. Control the oscilloscope using the traditional spectrum analyzer controls such as span and center frequency.

Display Features

Color LCD Display. Identify and differentiate waveforms easily with color coding. Waveforms, readouts, and inputs are color matched to increase productivity and reduce operating errors.

MultiView Zoom. To take advantage of the full resolution of the instrument you can zoom in on a waveform to see the fine details. Both vertical and horizontal zoom functions are available. Zoomed waveforms can be aligned, locked, and automatically scrolled.

-
- Measurement Features**
- Cursors.** Use cursors to take simple voltage, time, and frequency measurements.
 - Automatic Measurements.** Choose from a large palette of amplitude, time, and histogram measurements. You can customize the measurements by changing reference levels or by adding measurement gating.
- Trigger Features**
- Simple and Advanced Trigger Types.** Choose simple edge trigger or choose from eight advanced trigger types to help you capture a specific signal fault or event.
 - Dual Triggers.** Use the A (main) trigger system alone or add the B trigger to capture more complex events. You can use the A and B triggers together to set up a delay-by-time or delay-by-events trigger condition.
 - Comm Triggers.** Optional on TDS6000B Series. Use comm triggers to trigger on communication signals.
 - Serial Triggers.** Optional on TDS6000B Series. Use serial triggers to trigger on serial pattern data.
 - Recovered Clock and Data Triggers.** Use recovered clock and data internally to trigger your waveforms.
- Convenience Features**
- Autoset.** Use Autoset to quickly set up the vertical, horizontal, and trigger controls for a usable display.
 - Touch Screen Interface.** You can operate all oscilloscope functions (except the power switch) from the touch screen interface. If convenient, you can also install a mouse and keyboard to use the interface.
 - Toolbar or Menu Bar.** You can choose a toolbar operating mode that is optimized for use with the touch screen, or a PC-style menu-bar operating mode that is optimized for use with a mouse.
 - Open Desktop.** The oscilloscope is built on a Microsoft Windows software platform; the oscilloscope application program starts automatically when you apply power to the instrument. You can minimize the oscilloscope application and take full advantage of the built-in PC to run other applications. Moving waveform images and data into other applications is as simple as a copy/paste operation.

Dedicated Front Panel Controls. The front panel contains knobs and buttons to provide immediate access to the most common oscilloscope controls. Separate vertical controls are provided for each channel. The same functions are also available through the screen interface.

Data Storage and I/O. The oscilloscope has a removeable hard disk drive a CD-RW drive, that can be used for storage and retrieval of data. The oscilloscope has GPIB, USB, Centronics, and Ethernet ports for input and output to other devices.

Online Help. The oscilloscope has a complete online help system that covers all its features. The help system is context sensitive; help for the displayed control window is automatically shown if you touch the help button. Graphical aids in the help windows assist you in getting to the information you need. You can also access the help topics through a table of contents or index.

Specification Tables

Table 1-2: Channel input and vertical specifications

Characteristic	Description
Input channels	Four
Input coupling	DC and GND Channel input is disconnected from input termination when using GND coupling.
✓ Input impedance, DC coupled	50 Ω \pm 2.5% at 25 °C (77 °F), \pm 0.2% over 0 °C to 40 °C (32 °F to 122 °F)
Maximum voltage at input	<1 V _{RMS} for <100 mV settings and \leq 5 V _{RMS} for \geq 100 mV settings
Number of digitized bits	8 bits
Sensitivity range	10 mV/div to 1 V/division, in a 1-2-5 sequence

Table 1-2: Channel input and vertical specifications (Cont.)

Characteristic	Description	
✓ DC gain accuracy	10 mV/div to 99.5 mV/div	$\pm(2.5\% + 2\% \times \text{net offset})$
	100 mV/div to 1 V/div	$\pm(2.5\% + 2\% \times \text{net offset}/10)$
✓ DC voltage measurement accuracy	<i>Measurement type</i>	<i>DC accuracy (in volts)</i>
Average acquisition mode (≥ 16 averages)	10 mV/div to 99.5 mV/div	$\pm[(2.5\% + 2\% \times \text{net offset}) \times \text{reading} - \text{net offset} + \text{offset accuracy} + 0.08 \text{ division} \times \text{V/division}]$
	100 mV/div to 1 V/div	$\pm[(2.5\% + 2\% \times \text{net offset}/10) \times \text{reading} - \text{net offset} + \text{offset accuracy} + 0.08 \text{ division} \times \text{V/division}]$
Delta voltage measurement between any two averages of ≥ 16 waveforms acquired under the same setup and ambient conditions	10 mV/div to 99.5 mV/div	$\pm((2.5\% + 2\% \times \text{net offset}) \times \text{reading}) + 0.16 \text{ division} \times \text{V/division setting}$
	100 mV/div to 1 V/div	$\pm((2.5\% + 2\% \times \text{net offset}/10) \times \text{reading}) + 0.16 \text{ division} \times \text{V/division setting}$
	<i>where, net offset = offset - (position \times volts/division)</i>	
Nonlinearity, typical	< 1 DL, differential; ≤ 2 DL integral, independently based	
✓ Analog bandwidth	DC 50 Ω coupling, with amplitude tolerance of -3dB operating temperatures of 15 °C to 40 °C (59 °F to 104 °F) inclusive.	
	<i>SCALE range</i>	<i>Bandwidth</i>
	≥ 10 mV/div	TDS6604B DC to ≥ 6 GHz TDS6804B DC to ≥ 7 GHz
✓ Digitally enhanced bandwidth, DC coupled	DC 50 Ω coupling, with amplitude tolerance of -3dB operating temperatures of 15 °C to 40 °C (59 °F to 104 °F).	
	<i>SCALE range</i>	<i>Bandwidth</i>
	≥ 10 mV/div	TDS6804B DC to ≥ 8 GHz
Analog bandwidth with P7380 or TCA-BNC adapter for TDS6604B	Full bandwidth, operating ambient 15 °C to 30 °C (59 °F to 86 °F), derated by 20 MHz/°C above 30 °C (86 °F)	
Analog bandwidth with P7380 or TCA-BNC adapter for TDS6804B	8 GHz, Full enhanced bandwidth, operating ambient 15 °C to 30 °C (59 °F to 86 °F), derated by 20 MHz/°C above 30 °C (86 °F)	

Table 1-2: Channel input and vertical specifications (Cont.)

Characteristic	Description	
Rise time, typical	No digital bandwidth enhancement	
	TDS6604B	10 - 90% rise time is 70 ps vertical sensitivities ≥ 10 mV/div 20 - 80% rise time is 53 ps vertical sensitivities ≥ 10 mV/div
	TDS6804B	10 - 90% rise time is 62 ps vertical sensitivities ≥ 10 mV/div 20 - 80% rise time is 43 ps vertical sensitivities ≥ 10 mV/div
	Digital bandwidth enhancement	
	TDS6804B	10 - 90% rise time is 50 ps vertical sensitivities ≥ 10 mV/div 20 - 80% rise time is 35 ps vertical sensitivities ≥ 10 mV/div
Step response settling errors, typical	<i>SCALE range and step amplitude</i>	<i>Settling error at time after step</i>
	10 mV/div to 99.5 mV/div, with ≤ 1.5 V step	20 ns: $\leq 2\%$ 1 ms: $\leq 0.1\%$
	100 mV/div to 1 V/div, with ≤ 3 V step	20 ns: $\leq 2\%$ 1 ms: $\leq 0.2\%$
Pulse response, peak detect or envelope mode	Sample rate setting	Minimum pulse width
	20 GS/s or less	50 ps
Position range	± 5 divisions	
Offset range	<i>SCALE range</i>	<i>Offset range</i>
	10 mV/div to 50 mV/div	± 0.50 V
	50.5 mV/div to 99.5 mV/div	± 0.25 V
	100 mV/div to 500 mV/div	± 5 V
	505 mV/div to 1 V/div	± 2.5 V
✓ Offset accuracy	<i>Volts/div setting</i>	<i>Offset accuracy</i>
	10 mV/div to 99.5 V/div	$\pm(0.7\% \times \text{net offset} + 1.5 \text{ mV} + 0.1 \text{ div} \times \text{V/div setting})$
	100 mV/div to 1 V/div	$\pm(0.8\% \times \text{net offset} + 15 \text{ mV} + 0.1 \text{ div} \times \text{V/div setting})$
	<i>where, net offset = offset - (position \times volts/division)</i>	

Table 1-2: Channel input and vertical specifications (Cont.)

Characteristic	Description	
Effective bits, typical	Effective bits for 9 div p-p sine wave input sampled at 50 mV/division and 20 GS/s.	
	<i>Input frequency</i>	<i>Effective bits</i>
	10 MHz	5.7 bits
	1 GHz	5.5 bits
	1.5 GHz	5.4 bits
	2 GHz	5.2 bits
	2.5 GHz	5.0 bits
	3 GHz	4.9 bits
	4 GHz	4.5 bits
	5 GHz	3.7 bits
	6 GHz	3.5 bits
	6.5 GHz	3.0 bits
7 GHz	2.5 bits	
✓ Delay between channels	≤ 30 ps between any two channels with the same scale and coupling settings	
✓ Channel-to-channel cross-talk	≥ 15:1 at rated bandwidth, and ≥ 80:1 at ≤ 1.5 GHz or the rated bandwidth, whichever is less. Assumes two channels with the same scale settings	

Table 1-3: Horizontal and acquisition system specifications

Characteristic	Description	
Real-time sample rate range	<i>Number of channels acquired</i>	<i>Sample rate range</i>
	1, 2, 3, or 4	1.25S/s to 500 MS/s in a 1-2.5-5 sequence followed by 1.25GS/s, 2.5GS/s, 5GS/s, 10GS/s, 20GS/s
Equivalent-time sample rate or interpolated waveform rate range	10 GS/s, 12.5 GS/s, 20 GS/s, 25 GS/s, 40 GS/s, 50 GS/s, 62.5 GS/s, 80 GS/s, 100 GS/s, 125 GS/s, 160 GS/s, 200 GS/s, 250 GS/s, 312.5 GS/s, 320 GS/s, 400 GS/s, 500 GS/s, 625 GS/s, 800 GS/s, 1 TS/s, 2 T S/s	
Acquisition modes	Sample, Peak Detect, Hi Res, Average, and Envelope	

Table 1-3: Horizontal and acquisition system specifications (Cont.)

Characteristic	Description	
Record length	Maximum record length supported by acquisition hardware, at any sample rate	
<i>Mode</i>	<i>Channels</i>	<i>Record length</i>
Sample	1, 2, 3, or 4	32,000,000
Hi Res ≤1.25 GS/s sample rate	1, 2, 3, or 4	2,000,000
Seconds/division range	40 s/div to 25 ps/div	
Maximum FastFrame update rate, nominal	310,000 frames per second	
Frame length and maximum number of frames	Maximum number of frames for Sample or Peak Detect acquisition mode, depending on memory option installed	
	<i>Frame length</i>	<i>Maximum number of frames</i>
	50 points	Standard: 7008 Option 2M: 28552 Option 3M: 57280 Option 4M: 114736
	250 points	Standard: 4160 Option 2M: 16944 Option 3M: 33992 Option 4M: 68096
	500 points	Standard: 2752 Option 2M: 11232 Option 3M: 22536 Option 4M: 45152
	2000 points	Standard: 912 Option 2M: 3712 Option 3M: 7456 Option 4M: 14944
	5000 points	Standard: 384 Option 2M: 1584 Option 3M: 3184 Option 4M: 6384
✓ Internal time-base reference frequency	10 MHz ±2.5 ppm over any ≥100 ms interval. Aging <1 ppm per year	
✓ Long term sample rate and delay time accuracy	±2.5 ppm over any ≥100 ms interval	

Table 1-3: Horizontal and acquisition system specifications (Cont.)

Characteristic	Description										
Aperture uncertainty, typical	<p>Short term: ≤ 1.5 ps rms, records having duration ≤ 100 ms ≤ 800 fs rms, records having duration ≤ 10 μs</p> <p>Long term: ≤ 15 parts per trillion rms, records having duration ≤ 1 minute</p>										
Time base delay time range	≤ 0 ns to 250 s										
✓ Delta time measurement accuracy	<p>For a single channel, with signal amplitude > 5 divisions, reference level set at 50%, interpolation set to $\sin(x)/x$, volts/division set to ≥ 5 mV/div, with risetime $> 1.4 \times T_s$ and $< 4 \times T_s$ or 150 ps (whichever is greater) and acquired ≥ 10 mV/Div, where T_s is the sample period.</p> <table border="1"> <thead> <tr> <th>Conditions</th> <th>Accuracy</th> </tr> </thead> <tbody> <tr> <td>Single shot signal, sample acquisition mode, Full bandwidth</td> <td></td> </tr> <tr> <td>70 to 200 ps at 20 GSa/s. 140 to 400 ps at 10 GSa/s. 280 to 800 ps at 5 GSa/s.</td> <td>(0.06/sample rate + 2.5 ppm \times reading) RMS \pm (0.3/sample rate + 2.5 ppm \times reading) peak</td> </tr> <tr> <td>>100 averages, Full bandwidth selected (real or equivalent time)</td> <td></td> </tr> <tr> <td>70 to 200 ps</td> <td>\pm (4 ps + 2.5 ppm \times reading)</td> </tr> </tbody> </table>	Conditions	Accuracy	Single shot signal, sample acquisition mode, Full bandwidth		70 to 200 ps at 20 GSa/s. 140 to 400 ps at 10 GSa/s. 280 to 800 ps at 5 GSa/s.	(0.06/sample rate + 2.5 ppm \times reading) RMS \pm (0.3/sample rate + 2.5 ppm \times reading) peak	>100 averages, Full bandwidth selected (real or equivalent time)		70 to 200 ps	\pm (4 ps + 2.5 ppm \times reading)
Conditions	Accuracy										
Single shot signal, sample acquisition mode, Full bandwidth											
70 to 200 ps at 20 GSa/s. 140 to 400 ps at 10 GSa/s. 280 to 800 ps at 5 GSa/s.	(0.06/sample rate + 2.5 ppm \times reading) RMS \pm (0.3/sample rate + 2.5 ppm \times reading) peak										
>100 averages, Full bandwidth selected (real or equivalent time)											
70 to 200 ps	\pm (4 ps + 2.5 ppm \times reading)										

Table 1-4: Trigger specifications

Characteristic	Description			
Trigger jitter, typical	1.5 ps rms for low frequency fast rise time signal.			
✓ Edge Trigger Sensitivity, DC coupled	All sources, for vertical scale settings ≥ 10 mV/div and ≤ 1 V/div			
	<i>Trigger Source</i>	<i>Sensitivity</i>		
	Main trigger, Ch1 - Ch4	≤ 0.5 div DC to 50 MHz ≤ 1 div at 1.5 GHz ≤ 1.5 div at 3 GHz ≤ 3 div at 7 GHz		
	Delayed trigger, Ch1 - Ch4	≤ 0.5 div from DC to 50 MHz ≤ 1 div at 1.5 GHz ≤ 1.5 div at 3 GHz ≤ 3 div at 7 GHz		
	Auxiliary input	200 mV from DC to 50 MHz, increasing to 500 mV at 2 GHz		
Edge trigger sensitivity, typical	All sources, for vertical scale settings ≥ 10 mV/div and ≤ 1 V/div			
	<i>Trigger coupling</i>	<i>Sensitivity</i>		
	NOISE REJ	3×the DC-coupled limits		
	AC	Same as DC-coupled limits for frequencies > 100 Hz, attenuates signals < 100 Hz		
	HF REJ	Same as DC coupled limits for frequencies < 20 kHz, attenuates signals > 20 kHz		
	LF REJ	Same as DC coupled limits for frequencies > 200 kHz, attenuates signals < 200 kHz		
Auxiliary trigger input resistance and range, typical	50 Ω , ± 5 V (DC + peak AC)			
Lowest frequency for Set Level to 50%, typical	50 Hz			
Logic-type trigger sensitivity, typical	Logic type triggers: 1.0 div, from DC to 1 GHz Runt type: 1.0 div			
Logic-qualified pulse-type trigger minimum timing requirements	For vertical scale settings ≥ 10 mV/div and ≤ 1 V/div at the TekConnect input.			
	<i>Minimum logic qualifying event duration</i>	<i>Setup time</i>	<i>Hold time</i>	
	Glitch type	100 ps	40 ps	60 ps
	Runt type	150 ps	160 ps	-16 ps
	Time-qualified runt type	runt width + 330 ps	160 ps	175 ps

Table 1-4: Trigger specifications (Cont.)

Characteristic	Description		
Width type	190 ps	250 ps	175 ps
Transition type	330 ps	225 ps	175 ps
Window	190 ps	-20 ps	0 ps
Transition trigger, delta time range	1 ns to 1 s		
Setup/Hold hold time violation trigger, minimum clock pulse widths, typical	For vertical settings from 10 mV/div to 1V/div at the TekConnect input, the minimums are:		
✓ Timing accuracy for time-qualified triggers	<i>Minimum time from active clock edge to inactive edge</i>	<i>Minimum time from inactive clock edge to active edge</i>	
	User's hold time + 500 ps for hold times ≥ 0 . User's hold time + 1.5s for hold times < 0 .	500 ps	
	<i>Time range</i>	<i>Accuracy</i>	
	360 ps to 1.5 μ s	$\pm 10\%$ of setting	
	1.51 μ s to 1 s	± 100 ns	
Time range for time-qualified triggers	500 ps to 1 s		
The minimum to the maximum time range to which the instrument can be set for glitch trigger, pulse trigger, or time-qualified runt trigger.	<i>Time range</i>	<i>Time resolution</i>	
	500 ps to 950 ps	20 ps	
	1 ns to 10 ns	200 ps	
	10.5 ns to 20 ns	500 ps	
	21 ns to 50 ns	1 ns	
	52 ns to 100 ns	2 ns	
	104 ns to 200 ns	4 ns	
	210 ns to 500 ns	10 ns	
	520 ns to 2 μ s	20 ns	
	2.01 μ s to 10 ms	16 ns	
	10 ms to 100 ms	160 ns	
	100 ms to 1 s	2 μ s	

Table 1-4: Trigger specifications (Cont.)

Characteristic	Description	
Delayed Trigger time delay range	Delay time = 4.8 ns to >250 s	Event count = 1 to 10 ⁷
Trigger level or threshold range	<i>Trigger Source</i>	<i>Sensitivity</i>
	Any channel	±12 divisions from center of screen
	Auxiliary trigger input	±5 V
	Line trigger	±0 V, not settable
Trigger level or threshold accuracy, typical	Edge trigger, DC coupling, for signals having rise and fall times >1 ns	
	<i>Trigger Source</i>	<i>Accuracy</i>
	Any channel	± [(2% × setting - net offset) + (0.35 div × volts/div setting) + offset accuracy]
	Auxiliary	Not specified
	<i>where, net offset = offset - (position × volts/division)</i>	
Trigger position error, typical	Edge trigger, DC coupling, for signals having a slew rate at the trigger point of ≥ 0.5 division/ns	
	<i>Acquisition mode</i>	<i>Error</i>
	Sample, Average	± (1 waveform interval + 200 ps)
	Peak Detect, Envelope	± (2 waveform interval + 200 ps)
Trigger holdoff range	250 ns to 12 s, minimum resolution is 8 ns for settings ≤1.2 μs. A dither of ±4 ns is added to the holdoff setting	

Table 1-5: Serial Trigger specifications (optional)

Characteristic	Description
Serial trigger number of bits	64
Serial trigger encoding types	NRZ
✓ Serial trigger baud rate limits	Up to 1.25 Gbaud
✓ Clock recovery frequency range	1.5 MBd to 3.125 GBd. Above 1250 MHz the clock is only available internally as a trigger source. Below 1250 MHz the clock is also available at the Recovered Clock output along with regenerated data.

Table 1-5: Serial Trigger specifications (optional) (Cont.)

Characteristic	Description
✓Clock recovery jitter (RMS)	<0.25% bit period + 7 ps rms for PRBS data patterns. <0.25% bit period + 6 ps rms for repeating 0011 data patterns.
Clock recovery tracking/acquisition range	± 5% of requested baud.
Minimum signal amplitude needed for clock recovery, typical	1 division p-p up to 1.25 GBd 1.5 divisions p-p above 1.25 GBd

Table 1-6: Display specifications

Characteristic	Description
Display type	210.4 mm (8.3 in) (W)× 157.8 mm (6.2 in) (H), 263 mm (10.4 in) diagonal, liquid crystal active-matrix color display
Display resolution	1024 horizontal × 768 vertical pixels
Pixel pitch	0.2055 mm horizontal, 0.2055 mm vertical
Response time, typical	15 ms, white to black
Display refresh rate	59.94 frames per second
Viewing angle, typical	Horizontal: 60 degrees left, 60 degrees right Vertical: 60 degrees up, 45 degrees down
Displayed intensity levels	Each R-G-B input is 6 bits, giving 64 intensity levels of each color component

Table 1-7: Input/output port specifications

Characteristic	Description				
Rear-panel I/O ports	Ports located on the rear panel				
Video output port	Upper video port, DB-15 female connector, connect a second monitor to use dual-monitor display mode, supports Basic requirements of PC99 specifications				
Parallel port (IEEE 1284)	DB-25 connector, supports the following modes: -standard (output only) bidirectional (PS-2 compatible) bidirectional enhanced parallel port (IEEE 1284 standard, mode 1 or mode 2, v 1.7) -bidirectional high-speed extended capabilities				
Serial port	DB-9 COM1 port, uses NS16C550-compatible UARTS, transfer speeds up to 115.2 kb/s				
Keyboard port	PS-2 compatible, oscilloscope power must be off to make connection				
Mouse port	PS-2 compatible, oscilloscope power must be off to make connection				
LAN port	RJ-45 connector, supports 10 base-T and 100 base-T and gigabit ethernet				
Audio ports	Miniature phone jacks for stereo microphone input and stereo line output				
USB ports	Four rear panel and one front panel USB 2.0 connectors				
GPIB port	IEEE 488.2 standard interface				
XGA video port	15 pin D-subminiature connector on the rear panel				
✓ Probe Compensator Output Voltage, Offset Voltage, and Frequency	Front-panel BNC connector, requires Probe Cal Deskw Fixture for probe attachment				
	<table border="1"> <thead> <tr> <th><i>Output voltage</i></th> <th><i>Frequency</i></th> </tr> </thead> <tbody> <tr> <td>330 mV (from base to top) ± 20% into a 50 Ω load (Voh = 0 V, Vol = 330mV)</td> <td>1 kHz ± 5%</td> </tr> </tbody> </table>	<i>Output voltage</i>	<i>Frequency</i>	330 mV (from base to top) ± 20% into a 50 Ω load (Voh = 0 V, Vol = 330mV)	1 kHz ± 5%
<i>Output voltage</i>	<i>Frequency</i>				
330 mV (from base to top) ± 20% into a 50 Ω load (Voh = 0 V, Vol = 330mV)	1 kHz ± 5%				
✓ Auxiliary Output levels	Front-panel BNC connector, provides a TTL-compatible pulse (polarity selectable) for each A or B trigger (selectable)				
	<table border="1"> <thead> <tr> <th><i>V_{out high}</i></th> <th><i>V_{out low (true)}</i></th> </tr> </thead> <tbody> <tr> <td>≥2.5 V into open circuit, ≥1.0 V into 50 Ω load</td> <td>≤0.7 V with ≤4 mA sink, ≤0.25 V into 50 Ω load</td> </tr> </tbody> </table>	<i>V_{out high}</i>	<i>V_{out low (true)}</i>	≥2.5 V into open circuit, ≥1.0 V into 50 Ω load	≤0.7 V with ≤4 mA sink, ≤0.25 V into 50 Ω load
<i>V_{out high}</i>	<i>V_{out low (true)}</i>				
≥2.5 V into open circuit, ≥1.0 V into 50 Ω load	≤0.7 V with ≤4 mA sink, ≤0.25 V into 50 Ω load				
Auxiliary Output pulse width, typical	Pulse width varies, 1 μs minimum				
✓ External Reference input sensitivity	Vin ≥200 mV peak to peak for input frequencies between 9.8 MHz and 10.2 MHz				

Table 1-7: Input/output port specifications (Cont.)

Characteristic	Description				
External reference input frequency range					
Input voltage, maximum	7 V _{p-p}				
Input impedance	1.5 k Ω , C _{in} = 40 pF. Measure impedance at >100 kHz to make the blocking capacitor invisible.				
✓ External reference	9.8 MHz to 10.2 MHz. Run SPC whenever the external reference is more than 2000 ppm different than the internal reference or the reference at which SPC was last run.				
Input sensitivity	≥ 200 mV _{p-p} for input frequencies between 9.8 MHz and 10.2 MHz				
✓ Internal reference output					
Frequency	10 MHz $\pm \approx 2.5$ ppm over any ≥ 100 ms interval				
Output voltage	<table border="1"> <thead> <tr> <th>$V_{out\ high}$</th> <th>$V_{out\ low\ (true)}$</th> </tr> </thead> <tbody> <tr> <td>≥ 2.5 V into open circuit, ≥ 1.0 V into 50 Ω load</td> <td>≤ 0.7 V with ≤ 4 mA sink, ≤ 0.25 V into 50 Ω load</td> </tr> </tbody> </table>	$V_{out\ high}$	$V_{out\ low\ (true)}$	≥ 2.5 V into open circuit, ≥ 1.0 V into 50 Ω load	≤ 0.7 V with ≤ 4 mA sink, ≤ 0.25 V into 50 Ω load
$V_{out\ high}$	$V_{out\ low\ (true)}$				
≥ 2.5 V into open circuit, ≥ 1.0 V into 50 Ω load	≤ 0.7 V with ≤ 4 mA sink, ≤ 0.25 V into 50 Ω load				

Table 1-8: Data storage specifications

Characteristic	Description
Nonvolatile memory retention time, typical	≥ 5 years
CDROM-RW	Rear-panel CDROM-RW drive, read write
Hard disk	Rear-panel, removeable hard disk drive, 40 GB capacity

Table 1-9: Power source specifications

Characteristic	Description
Power consumption	≤ 500 Watts (650 VA)
Source voltage and frequency	100 to 240 V $\pm 10\%$, 50 Hz to 60 Hz 115 V $\pm 10\%$, 400 Hz CAT II
Fuse rating	Either one of the following sizes can be used, each size requires a different fuse cap. Both fuses must be the same type

Table 1-9: Power source specifications (Cont.)

Characteristic	Description
0.25 in × 1.25 in size	UL198G and CSA C22.2, No. 59, fast acting: 8 A, 250 V (Tektronix part number 159-0046-00, Bussman ABC-8, Littelfuse 314008)
5 mm × 20 mm size	IEC127, sheet 1, fast acting "F", high breaking capacity: 6.3 A, 250 V (Bussman GDA 6.3, Littelfuse 21606.3)

Table 1-10: Mechanical specifications

Characteristic	Description	
Weight		
Benchtop configuration	21 kg (47 lbs) without front cover, power cord, pouch 23 kg (50 lbs) with front cover, power cord, pouch 24 kg (53 lbs) packaged for shipment	
Rackmount kit	22.4 kg (49 lbs) rackmounted instrument 5.6 kg (12.2 lbs) kit packaged for domestic shipment	
Dimensions		
Benchtop configuration	With front cover	Without front cover
	278 mm (10.95 in) height, 456 mm (17.96 in) width	277 mm (10.9 in) height, 456 mm (17.96 in) width 581 mm (22.85 in) depth
Rackmount configuration (Option 1R)	With rack handles	Without rack handles
	267 mm (10.5 in) height 502 mm (19.75 in) width 642 mm (25.26 in) depth	267 mm (10.5 in) height 482 mm (19 in) width 591 mm (23.26 in) depth
Cooling	Fan-forced air circulation with no air filter.	
Required clearances	Top	0 mm (0 in)
	Bottom	0 mm (0 in) when standing on feet, flip stands down
	Left side	76 mm (3 in)
	Right side	76 mm (3 in)
	Rear	0 mm (0 in) on rear feet
Construction material	Chassis parts are constructed of aluminum alloy, front panel is constructed of plastic laminate, circuit boards are constructed of glass laminate, outer shell is spray painted finished.	

Table 1-11: Environmental specifications

Characteristic	Description
Temperature, operating	5 °C to +40 °C (41 °F to +104 °F), excluding CDROM-RW drives +10 °C to +40 °C (50 °F to +104 °F), including CDROM-RW drive
Nonoperating	-22 °C to +60 °C (8 °F to +140 °F)
Humidity, operating	20% to 80% relative humidity with a maximum wet bulb temperature of +29 °C (+84 °F) at or below +50 °C (+122 °F), noncondensing Upper limit derated to 25% relative humidity at +50 °C (+122 °F)
Nonoperating	5% to 90% relative humidity with a maximum wet bulb temperature of +29 °C (+84 °F) at or below +60 °C (+140 °F), noncondensing Upper limit derated to 20% relative humidity at +60 °C (+140 °F)
Altitude, operating	3,048 m (10,000 ft)
Nonoperating	12,190 m (40,000 ft)
Random vibration, operating	0.27 g _{RMS} from 5 Hz to 500 Hz, 10 minutes on each axis, 3 axes, 30 minutes total, with CDROM-RW installed
Nonoperating	2.28 g _{RMS} from 5 Hz to 500 Hz, 10 minutes on each axis, 30 minutes total, 3 axes

Table 1-12: Certifications and compliances

Category	Standards or description												
<p>EC Declaration of Conformity - EMC</p>	<p>Meets intent of Directive 89/336/EEC for Electromagnetic Compatibility. Compliance was demonstrated to the following specifications as listed in the Official Journal of the European Union:</p> <p>EN 61326 Emissions, Annex D ^{1, 3} Class A Radiated and Conducted Emissions</p> <p>EN 61326 Immunity, Annex D ^{1,2}:</p> <table border="0"> <tr> <td style="padding-right: 20px;">IEC 61000-4-2</td> <td>Electrostatic Discharge Immunity ±4 kV contact discharge, ±8 kV air discharge, performance criterion for tests with transient electromagnetic phenomenon</td> </tr> <tr> <td>IEC 61000-4-3</td> <td>RF field immunity 3 V/m, 80 MHz to 1 GHz, 80% amplitude modulated with a 1 kHz sinewave performance criterion for test with continuously present electromagnetic phenomenon</td> </tr> <tr> <td>IEC 61000-4-4</td> <td>Electrical Fast Transient/Burst Immunity 1 kV on AC mains, 500 V on I/O cables, performance criterion for tests with transient electromagnetic phenomenon</td> </tr> <tr> <td>IEC 61000-4-5</td> <td>AC Surge Immunity 1 kV differential mode, 1 kV common mode, performance criterion tests with transient electromagnetic phenomenon</td> </tr> <tr> <td>IEC 61000-4-6</td> <td>RF Conducted Immunity 3 V, 150 kHz to 80 MHz, amplitude modulated with a 1 kHz sinewave, performance criterion for tests with continuously present electromagnetic phenomenon</td> </tr> <tr> <td>IEC 61000-4-11</td> <td>AC Mains Voltage Dips and Interruption Immunity 100% reduction for one cycle, performance criterion for tests with transient electromagnetic phenomenon⁴</td> </tr> </table> <p>EN 61000-3-2 Power Harmonic Current Emissions</p> <p>EN 61000-3-3 Voltage Changes, Fluctuations, and Flicker</p> <p>¹ If interconnect cables are used, they must be low-EMI shielded cables such as the following Tektronix part numbers or their equivalents: 012-0991-01, 012-0991-02 or 012-0991-03 GPIB Cable; 012-1213-00 (or CA part number 0294-9) RS-232 Cable; 012-1214-00 Centronics Cable; or LCOM part number CTL3VGAMM-5 VGA Cable.</p> <p>² The performance criterion for when the oscilloscope is subjected to the continuously present electromagnetic phenomenon: — 10 mV/division to 1 V/division: ≤0.4 division waveform displacement or ≤0.8 division increase in peak-to-peak noise Performance criterion for when the oscilloscope is subjected to transient electromagnetic phenomenon: — Temporary, self-recoverable degradation or loss of performance is allowed, but no change of actual operating state or loss of stored data is allowed</p> <p>³ Radiated emissions may exceed the levels specified in EN 61326 when this instrument is connected to a test object.</p> <p>⁴ When the nominal mains voltage is less than 100 Volts, the oscilloscope may reboot when subjected to a one cycle mains voltage interruption.</p>	IEC 61000-4-2	Electrostatic Discharge Immunity ±4 kV contact discharge, ±8 kV air discharge, performance criterion for tests with transient electromagnetic phenomenon	IEC 61000-4-3	RF field immunity 3 V/m, 80 MHz to 1 GHz, 80% amplitude modulated with a 1 kHz sinewave performance criterion for test with continuously present electromagnetic phenomenon	IEC 61000-4-4	Electrical Fast Transient/Burst Immunity 1 kV on AC mains, 500 V on I/O cables, performance criterion for tests with transient electromagnetic phenomenon	IEC 61000-4-5	AC Surge Immunity 1 kV differential mode, 1 kV common mode, performance criterion tests with transient electromagnetic phenomenon	IEC 61000-4-6	RF Conducted Immunity 3 V, 150 kHz to 80 MHz, amplitude modulated with a 1 kHz sinewave, performance criterion for tests with continuously present electromagnetic phenomenon	IEC 61000-4-11	AC Mains Voltage Dips and Interruption Immunity 100% reduction for one cycle, performance criterion for tests with transient electromagnetic phenomenon ⁴
IEC 61000-4-2	Electrostatic Discharge Immunity ±4 kV contact discharge, ±8 kV air discharge, performance criterion for tests with transient electromagnetic phenomenon												
IEC 61000-4-3	RF field immunity 3 V/m, 80 MHz to 1 GHz, 80% amplitude modulated with a 1 kHz sinewave performance criterion for test with continuously present electromagnetic phenomenon												
IEC 61000-4-4	Electrical Fast Transient/Burst Immunity 1 kV on AC mains, 500 V on I/O cables, performance criterion for tests with transient electromagnetic phenomenon												
IEC 61000-4-5	AC Surge Immunity 1 kV differential mode, 1 kV common mode, performance criterion tests with transient electromagnetic phenomenon												
IEC 61000-4-6	RF Conducted Immunity 3 V, 150 kHz to 80 MHz, amplitude modulated with a 1 kHz sinewave, performance criterion for tests with continuously present electromagnetic phenomenon												
IEC 61000-4-11	AC Mains Voltage Dips and Interruption Immunity 100% reduction for one cycle, performance criterion for tests with transient electromagnetic phenomenon ⁴												
<p>Australia/New Zealand Declaration of Conformity — EMC</p>	<p>Complies with EMC provision of Radiocommunications Act per the following standard(s): AS/NZS 2064.1/2 Industrial, Scientific, and Medical Equipment: 1992, Class A.</p>												

Table 1- 12: Certifications and compliances (Cont.)

Category	Standards or description
EC Declaration of Conformity - Low Voltage	<p>Compliance was demonstrated to the following specification as listed in the Official Journal of the European Union:</p> <p>Low Voltage Directive 73/23/EEC, amended by 93/68/EEC</p> <p>EN 61010-1/A2:1995 Safety requirements for electrical equipment for measurement control and laboratory use.</p>
U.S. Nationally Recognized Testing Laboratory Listing	<p>UL3111-1, First Edition Standard for electrical measuring and test equipment.</p>
Canadian Certification	<p>CAN/CSA C22.2, No. 1010.1-92 Safety requirements for electrical equipment for measurement, control, and laboratory use.</p>
Additional Compliance	<p>IEC61010-1 Safety requirements for electrical equipment for measurement, control, and laboratory use.</p>
Installation (Overvoltage) Category	<p>Terminals on this product may have different installation (overvoltage) category designations. The installation categories are:</p> <p>CAT III Distribution-level mains (usually permanently connected). Equipment at this level is typically in a fixed industrial location.</p> <p>CAT II Local-level mains (wall sockets). Equipment at this level includes appliances, portable tools, and similar products. Equipment is usually cord-connected.</p> <p>CAT I Secondary (signal level) or battery operated circuits of electronic equipment.</p>
Pollution Degree	<p>A measure of the contaminates that could occur in the environment around and within a product. Typically the internal environment inside a product is considered to be the same as the external. Products should be used only in the environment for which they are rated.</p> <p>Pollution Degree 2 Normally only dry, nonconductive pollution occurs. Occasionally a temporary conductivity that is caused by condensation must be expected. This location is a typical office/home environment. Temporary condensation occurs only when the product is out of service.</p>
Safety Certification Compliance	
Equipment Type	Test and measuring
Safety Class	Class 1 (as defined in IEC 61010-1, Annex H) - grounded product
Pollution Degree	Pollution Degree 2 (as defined in IEC 61010-1). Note: Rated for indoor use only.

Performance Verification

Two types of Performance Verification procedures can be performed on this product: *Brief Procedures* and *Performance Tests*. You may not need to perform all of these procedures, depending on what you want to accomplish.

- To rapidly confirm that the oscilloscope functions and was adjusted properly, just do the brief procedures under *Self Tests*, which begin on page 3-1.

Advantages: These procedures are quick to do, require no external equipment or signal sources, and perform extensive functional and accuracy testing to provide high confidence that the oscilloscope will perform properly. They can be used as a quick check before making a series of important measurements.

- To further check functionality, first do the *Self Tests* just mentioned; then do the brief procedures under *Functional Tests* that begin on page 3-2.

Advantages: These procedures require minimal additional time to perform, require no additional equipment other than a BNC cable and BNC-to-SMA adapter or a TCA-SMA adapter, and these procedures more completely test the internal hardware of the oscilloscope. They can be used to quickly determine if the oscilloscope is suitable for putting into service, such as when it is first received.

- If more extensive confirmation of performance is desired, do the *Performance Tests*, beginning on page 4-1, after doing the *Functional* and *Self Tests* mentioned above.

Advantages: These procedures add direct checking of the warranted specifications that are marked with the ✓ symbol. These procedures require specific test equipment. (See *Table 4-1: Test equipment* on page 4-2).

If you are not familiar with operating this oscilloscope, read the oscilloscope reference or user manuals or explore the online help.

Conventions

Throughout these procedures the following conventions apply:

- Each test procedure uses the following general format:

Title of Test

Equipment Required

Prerequisites

Procedure

- Each procedure consists of as many steps, substeps, and subparts as required to do the test. Steps, substeps, and subparts are sequenced as follows:

1. First Step

- a. First Substep

- First Subpart

- Second Subpart

- b. Second Substep

2. Second Step

- In steps and substeps, the lead-in statement in italics instructs you what to do, while the instructions that follow tell you how to do it, as in the example step below:

Initialize the oscilloscope: Push the front-panel **DEFAULT SETUP** button.

- Where instructed to use a control in the display or a front-panel button or knob, the name of the control, button, or knob appears in boldface type. Where instructed to make or verify a setting, the value of the setting also appears in boldface type.

STOP. *The **STOP** notation at the left is accompanied by information you must read to do the procedure properly.*

- The term “toolbar” refers to a row of buttons at the top of the display. The term “menu bar” refers to a row of menus at the top of the display. You can switch between toolbar and menu bar operating modes by pushing the button near the top right corner of the display. See Figure 2-1.

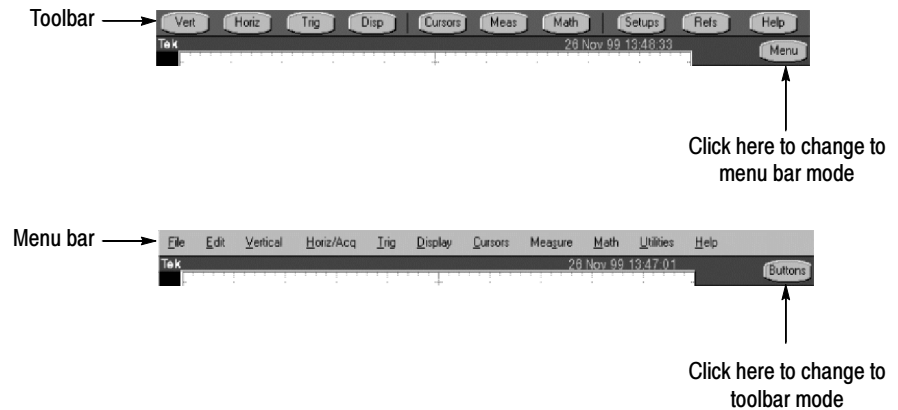

Figure 2-1: Toolbar and menu bar

- The procedures assume you have connected a mouse to the oscilloscope so that you can click on the screen controls. If you have not connected a mouse, you can use the touch screen to operate all the screen controls.

Brief Procedures

The *Self Tests* use internal routines to confirm basic functionality and proper adjustment. No test equipment is required to do these test procedures.

The *Functional Tests* utilize the probe-compensation output at the front panel as a test-signal source for further verifying that the oscilloscope functions properly. A BNC cable and a BNC-to-SMA adaptor or a TCA-SMA adapter are required to do these test procedures.

Self Tests

This procedure uses internal routines to verify that the oscilloscope functions and was adjusted properly. No test equipment or hookups are required.

Verify Internal Adjustment, Self Compensation, and Diagnostics

Equipment required	None
Prerequisites	Power on the oscilloscope and allow a 20 minute warm-up before doing this procedure.

1. *Verify that internal diagnostics pass:* Do the following substeps to verify passing of internal diagnostics.
 - a. *Display the System diagnostics menu:*
 - If the oscilloscope is in toolbar mode, click the **MENU** button to put the oscilloscope into menu bar mode.
 - Select **Instrument Diagnostics** from the **Utilities** menu and. This displays the diagnostics control window.
 - b. *Run the System Diagnostics:*
 - First disconnect any input signals from all four channels.
 - Click the **Run** button in the diagnostics control window.
 - c. *Wait:* The internal diagnostics do an exhaustive verification of proper oscilloscope function. This verification may take several minutes. When the verification is finished, the resulting status will appear in the diagnostics control window.

NOTE. *If diagnostic error message 512 is displayed, run signal-path compensation then re-run diagnostic.*

- d. *Verify that no failures are found and reported on-screen. All tests should pass.*
- e. *Run the signal-path compensation routine:*
 - Select **Instrument Calibration** from the **Utilities** menu This displays the instrument calibration control window.
 - If required because the instrument is in service mode, select the **Signal Path** button under Calibration Area.

NOTE. *Signal Path Compensation is not valid until the instrument reaches a valid temperature. Calibration Status must be **Temp**.*

- Click the **Calibrate** button to start the routine.
 - f. *Wait:* Signal-path compensation may take five to fifteen minutes to run.
 - g. *Confirm signal-path compensation returns passed status:* Verify that the word **Pass** appears in the instrument calibration control window.
2. *Return to regular service:* Click the **Close** button to exit the instrument calibration control window.

Functional Tests

The purpose of these procedures is to confirm that the oscilloscope functions properly. The only equipment required is a P7240 probe, a probe calibration and deskew fixture, a SMA cable, a BNC cable, BNC-to-SMA adapter or TCA-SMA adapter.

STOP. *These procedures verify functions that the oscilloscope features operate. They do not verify that they operate within limits.*

Therefore, when the instructions in the functional tests that follow call for you to verify that a signal appears on the screen “that is about five divisions in amplitude” or “has a period of about six horizontal divisions,” etc., do NOT interpret the quantities given as limits. Operation within limits is checked in Performance Tests, which begin on page 4-1.

STOP. Make no changes to the front-panel settings unless they are called out in the procedures. Each verification procedure will require you to set the oscilloscope to certain default settings before verifying functions. If you make changes to these settings, other than those called out in the procedure, you may obtain invalid results. In this case, just redo the procedure from step 1.

When you are instructed to press a front-panel or screen button, the button may already be selected (its label will be highlighted). If this is the case, it is not necessary to press the button.

Verify All Input Channels

Equipment required	<p>One P7240 probe</p> <p>One probe calibration and deskew fixture, Tektronix part number 067-0484-xx</p> <p>One BNC cable, Tektronix part number 012-0076-00 or the cable 012-0208-00, use adapter 015-0554-00 or 015-1018-00 using a BNC cable</p>
Prerequisites	None

1. *Initialize the oscilloscope:* Push the front-panel **DEFAULT SETUP** button.
2. *Hook up the signal source:* Connect one end of the BNC cable to the PROBE COMPENSATION output connector in the oscilloscope. Connect the remaining end of the BNC cable to the GAIN CAL SIG connector of the fixture as shown in Figure 3-1 on page 3-4.
3. Install a P7240 probe in the channel input you want to test (beginning with CH 1).
4. Connect the probe tip to the GAIN CAL pins on the fixture as shown in Figure 3-1 on page 3-4.

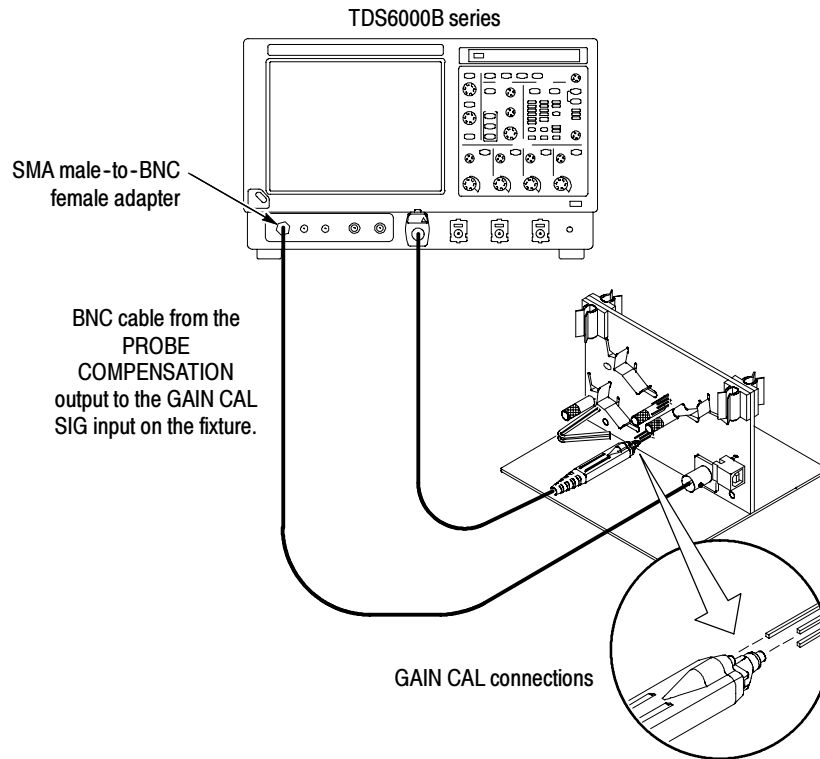

Figure 3-1: Universal test hookup for functional tests - CH 1 shown

5. *Turn off all channels:* If any of the front-panel channel buttons are lighted, push those buttons to turn off the displayed channels. See Figure 3-2.

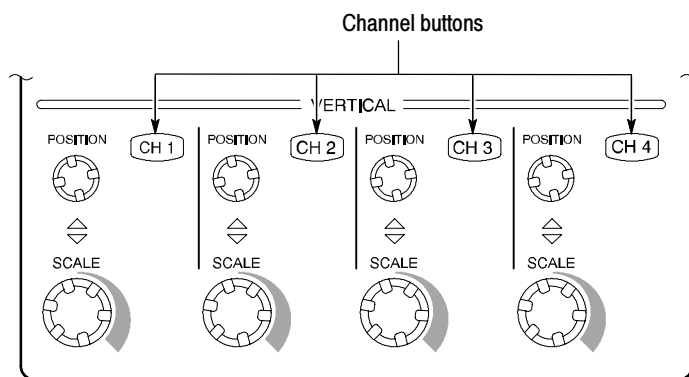

Figure 3-2: Channel button location

6. *Select the channel to test:* Push the channel button for the channel that you are currently testing. The button lights, and the channel display comes on.

7. *Set up the oscilloscope:*

- Push the front panel **AUTOSET** button. This sets the horizontal and vertical scale and vertical offset for a usable display and sets the trigger source to the channel that you are testing.
- Pull down the **Vert** menu, select Vertical Setup, and then touch **Offset**. Confirm that the Ch1 Offset is about **-200 mV/250 mV**.

8. *Verify that the channel is operational:* Confirm that the following statements are true.

- The vertical scale readout for the channel under test shows a setting of about 200 mV, and a square-wave probe-compensation signal about 3 divisions in amplitude (about 784 mV) is on the screen.
- Verify that the vertical scale readout and the waveform amplitude for the channel under test are as shown in Table 3-1.

Table 3-1: Vertical settings

Setting	TDS6000B Series	
	With P7240 or P7260	Without probe
Scale	200 mV	100 mV
Waveform amplitude	3.0 divisions	-3.0 divisions

- The front-panel vertical **POSITION** knob (for the channel that you are testing) moves the signal up and down the screen when rotated.
 - Turning the vertical **SCALE** knob counterclockwise (for the channel you are testing) decreases the amplitude of the waveform on-screen, turning the knob clockwise increases the amplitude, and returning the knob to 100 mV returns the amplitude to about 6 divisions.
9. *Verify that the channel acquires in all acquisition modes:* Click the Horiz/Acq menu and select **Horizontal/Acquisition Setup**. . . . Click the **Acquisition** tab in the control window that displays. Click each of the six acquisition modes and confirm that the following statements are true.
- Sample mode displays an actively acquiring waveform on-screen. (Note that there is a small amount of noise present on the square wave).
 - Peak Detect mode displays an actively acquiring waveform on the screen with the noise present in Sample mode “peak detected.”
 - Hi Res mode displays an actively acquiring waveform on the screen with the noise that was present in Sample mode reduced.

- Average mode displays an actively acquiring waveform on the screen with the noise reduced.
 - Envelope mode displays an actively acquiring waveform on the screen with the noise displayed.
 - Waveform Database or WfmDB mode displays an actively acquiring and displays a waveform that is the accumulation of several acquisitions.
10. *Test all channels:* Repeat steps 2 through 9 until all four input channels are verified.
 11. *Remove the test hookup:* Disconnect the BNC cable, fixture, and the probe from the channel input and the probe compensation output.

Verify the Time Base

Equipment required	One SMA cable, such as Tektronix part number 174-1427-XX One TCA-SMA adapter
Prerequisites	None

1. *Initialize the oscilloscope:* Push the front-panel **DEFAULT SETUP** button.
2. *Hook up the signal source:* Connect the SMA cable from the probe COMPENSATION output to the CH 1 input through a TCA-SMA adapter as shown in Figure 3-3.

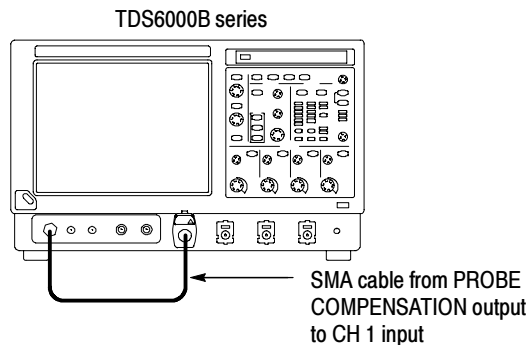

Figure 3- 3: Setup for time base test

3. *Set up the oscilloscope:* Push the front panel **AUTOSET** button.
4. Click the **Vert** menu, select Vertical Setup, and then touch **Offset**. Adjust the Ch1 Offset to approximately **-0.15 V** using the multipurpose knob.
5. Set the **Vertical SCALE** to **100 mV** per division.
6. *Set the time base:* Set the horizontal **SCALE** to **200 μ s/div**. The time-base readout is displayed at the bottom of the graticule.

7. *Verify that the time base operates:* Confirm the following statements.
 - One period of the square-wave probe-compensation signal is about five horizontal divisions on-screen for the 200 $\mu\text{s}/\text{div}$ horizontal scale setting.
 - Rotating the horizontal **SCALE** knob clockwise expands the waveform on the screen (more horizontal divisions per waveform period), counterclockwise rotation contracts it, and returning the horizontal scale to 200 $\mu\text{s}/\text{div}$ returns the period to about five divisions.
 - The horizontal **POSITION** knob positions the signal left and right on the screen when rotated.
8. *Verify horizontal delay:*
 - a. *Center a rising edge on screen:*
 - Set the horizontal **POSITION** knob so that the rising edge where the waveform is triggered is lined up with the center horizontal graticule.
 - Change the horizontal **SCALE** to **40 $\mu\text{s}/\text{div}$** . The rising edge of the waveform should remain near the center graticule and the falling edge should be off screen.
 - b. *Turn on and set horizontal delay:*
 - Click the Horiz/Acq menu and select **Horizontal/Acquisition Setup. . . .**
 - Click the **Horizontal** tab in the control window that displays.
 - Click the **Delay Mode** button to turn delay on.
 - Double-click the **Horiz Delay** control in the control window to display the pop-up keypad. Click the keypad buttons to set the horizontal delay to 500 μs , and then click the **ENTER** key.
 - c. *Verify the waveform:* Verify that a falling edge of the waveform is within a few divisions of center screen.
 - d. *Adjust the horizontal delay:* Rotate the upper multipurpose knob to change the horizontal delay setting. Verify that the falling edge shifts horizontally. Rotate the front-panel horizontal **POSITION** knob. Verify that this knob has the same effect (it also adjusts delay, but only when delay mode is on).
 - e. *Verify the delay toggle function:*
 - Rotate the front-panel horizontal **POSITION** knob to center the rising edge horizontally on the screen.

- Change the horizontal **SCALE** to **4 $\mu\text{s}/\text{div}$** . The falling edge of the waveform should remain near the center graticule. If not, readjust the delay setting to center the rising edge.
 - Push the front-panel **DELAY** button several times to toggle delay off and on and back off again. Verify that the display switches quickly between two different points in time (the rising and falling edges of this signal).
9. *Remove the test hookup:* Disconnect the SMA cable from the channel input and the probe compensation output.

Verify the A (Main) and B (Delayed) Trigger Systems

Equipment required	One SMA cable, such as Tektronix part number 174-1427-00 One TCA-SMA adapter
Prerequisites	None

1. *Initialize the oscilloscope:* Push the front-panel **DEFAULT SETUP** button.
2. *Hook up the signal source:* Connect the SMA cable from the probe **COMPENSATION** output to the CH 1 input through a TCA-SMA adapter as shown in Figure 3-4.

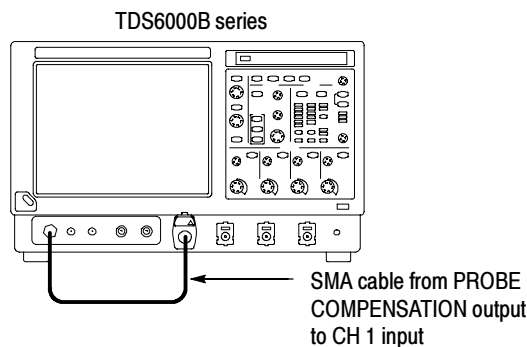

Figure 3- 4: Setup for trigger test

3. *Set up the oscilloscope:* Push the front-panel **AUTOSET** button.
4. Click the **Vert** menu, select Vertical Setup, and then click **Offset**. Adjust the Ch1 Offset to approximately **-0.15 V** using the multipurpose knob.
5. Set the **Vertical SCALE** to **100 mV** per division.

6. *Verify that the main trigger system operates:* Confirm that the following statements are true:
 - The trigger level readout for the A (main) trigger system changes with the trigger-LEVEL knob.
 - The trigger-LEVEL knob can trigger and untrigger the square-wave signal as you rotate it. (Leave the signal untriggered).
 - Pushing the front-panel trigger LEVEL knob sets the trigger level to the 50% amplitude point of the signal and triggers the signal that you just left untriggered. (Leave the signal triggered.)
7. *Verify that the delayed trigger system operates:*
 - a. *Set up the delayed trigger:*
 - Click the Trig menu and select **A — B Trigger Sequence. . . .** This displays the A→B Sequence tab of the trigger setup control window.
 - Click the **Trig After Time** button under A Then B.
 - Click the **Level** control in the control window.
 - b. *Confirm that the following statements are true:*
 - The trigger-level readout for the B trigger system changes as you turn the lower multipurpose knob.
 - As you rotate the lower multipurpose knob, the square-wave probe-compensation signal can become triggered and untriggered. (Leave the signal triggered.)
 - c. *Verify the delayed trigger counter:*
 - Double-click the **Trig Delay** control to pop up a numeric keypad for that control.
 - Click the keypad to enter a trigger delay time of 1 second and then click **Enter**.
 - Set front-panel control to NORM.
 - Verify that the trigger READY indicator on the front panel flashes about once every second as the waveform is updated on-screen.
8. *Remove the test hookup:* Disconnect the SMA cable from the channel input and the probe compensation output.

Performance Tests

This section contains a collection of manual procedures for checking that the TDS6000B Series oscilloscopes performs as warranted.

The procedures are arranged in four logical groupings: *Signal Acquisition System Checks*, *Time Base System Checks*, *Triggering System Checks*, and *Output Ports Checks*. They check all the characteristics that are designated as checked in *Specifications*. (The characteristics that are checked appear with a ✓ in *Specifications*).

STOP. *These procedures extend the confidence level provided by the basic procedures described on page 3-1. The basic procedures should be done first, then these procedures performed if desired.*

Prerequisites

The tests in this section comprise an extensive, valid confirmation of performance and functionality when the following requirements are met:

- The cabinet must be installed on the instrument.
- You must have performed and passed the procedures under *Self Tests*, found on page 3-1, and those under *Functional Tests*, found on page 3-2.
- A signal-path compensation must have been done within the recommended calibration interval and at a temperature within ± 5 °C of the present operating temperature. A signal-path compensation must have been done at an ambient humidity within 25% of the current ambient humidity and after having been at that humidity for at least 4 hours.
- The oscilloscope must have been last adjusted at an ambient temperature between +20 °C and +30 °C, must have been operating for a warm-up period of at least 20 minutes, and must be operating at an ambient temperature as listed in Table 1-11 on page 1-17. (The warm-up requirement is usually met in the course of meeting the Self Tests and Functional Tests prerequisites listed above).
- Sensors or spitter adapter setups should be supported to avoid stress or torque when connected to the DUT.

Equipment Required

Procedures starting on page 4-13, use external, traceable signal sources to directly check warranted characteristics. Table 4-1 lists the required equipment.

Table 4-1: Test equipment

Item number and description	Minimum requirements	Example	Purpose
1. Attenuator, 10X (two required)	Ratio: 10X; impedance 50 Ω ; connectors: female BNC input, male BNC output	Tektronix part number 011-0059-02	Signal Attenuation
2. Attenuator, 5X	Ratio: 5X; impedance 50 Ω ; connectors: female BNC input, male BNC output	Tektronix part number 011-0060-02	Signal Attenuation
3. Termination, 50 Ω (three required)	Impedance 50 Ω ; connectors: female BNC input, male BNC output	Tektronix part number 011-0049-01	Signal Termination for Channel Delay Test
4. Cable, Precision 50 Ω Coaxial (three required)	50 Ω , 36 in, male-to-male BNC connectors	Tektronix part number 012-0482-00	Signal Interconnection
5. Connector, Dual-Banana (two required)	Female BNC-to-dual banana	Tektronix part number 103-0090-00	Various Accuracy Tests
6. Connector, BNC "T"	Male BNC-to-dual female BNC	Tektronix part number 103-0030-00	Used to Test Delta Time Measurement Accuracy
7. Power divider	50 Ω , 3 SMA female connectors	Tektronix part number 015-0565-00	Checking Delay Between Channels
8. Probe, 10X	A P7240 probe	Tektronix part number P7240	Signal Interconnection
9. Generator, DC Calibration	Variable amplitude to ± 7 V; accuracy to 0.1%	Wavetek 9500 ¹	Checking DC Offset, Gain, Measurement Accuracy, and Maximum Input Voltage
10. Generator, Calibration	500 mV square wave calibrator amplitude; accuracy to 0.25%	Wavetek 9500 ¹	To check accuracy of Signal Out
11. Timer-counter	25 MHz, 1 s gate	Advantest R5360	Checking long-term sample rate and delay time accuracy
12. Generator, Sine-Wave ³	5 kHz to at least 8 GHz. Variable amplitude from 60 mV to 2 V _{p-p} into 50 Ω . Frequency error <2.0%	Anritsu MG3692A Synthesizer Signal Generator Options 2, 4, 15	Checking Analog Bandwidth, Trigger Sensitivity, Sample-rate, External Clock, and Delay-Time Accuracy
13. Meter, Level and Power Sensor	Frequency range: 10 MHz to the instrument bandwidth. Amplitude range: 6 mV _{p-p} to 2 V _{p-p}	Rohde & Schwarz NRVS and NRV-Z402	Checking Analog Bandwidth and Trigger Sensitivity
14. Splitter, Power	N female (3) Frequency range: DC to 8 GHz. Tracking: >2.0%	Agilent part number 11667A	Checking Analog Bandwidth
15. Adapter	Two Male N-to-female BNC	Tektronix part number 103-0045-00	Checking Analog Bandwidth

Table 4-1: Test equipment (Cont.)

Item number and description	Minimum requirements	Example	Purpose
16. Adapter	Two Male N-to-female SMA	Amphenol part number 901-294	Checking the sinewave generator leveling
17. Adapter	Male N-to-male SMA	Maury part number 8023D1	Checking Analog Bandwidth
18. Adapter (three required)	SMA female-to-female	Tektronix part number 015-1012-00	Checking the delay between channels
19. Adapter (three required)	SMA male-to-female BNC	Tektronix part number 015-1018-00	Checking the delay between channels
20. Adapter (four required)	SMA male-to-BNC female SMA female to BNC Male	TCA-BNC or TCA-SMA and SMA male-to-BNC female adapter (Tektronix part number 015-0554-00 or 015-1018-00 or 015-0572-XX)	Signal interconnection
21. Pulse Generator	250 MHz, ≤ 1 ns rise time, 5 V out	Wavetek 9500 ^{1,2}	Used to Test Delta Time Measurement Accuracy
22. Cable, Coaxial (two required)	50 Ω , 20 in, male-to-male SMA connectors	Tektronix part number 174-1427-00	Used to Test Delta Time Measurement Accuracy
23. Adapter	SMA "T", male to 2 SMA female	Tektronix part number 015-1016-00	Used to Test Delta Time Measurement Accuracy
24. Adapter	SMA female to BNC male	Tektronix part number 015-0572-00	Used to Test Delta Time Measurement Accuracy
25. Adapter	BNC male to female elbow	Tektronix part number 103-0031-00	Used to Test Delta Time Measurement Accuracy
26. Termination	Short circuit, SMA connector	Tektronix part number 015-1021-00	Used to Test Delta Time Measurement Accuracy
27. Attenuator, 2X	Ratio: 2X; impedance 50 Ω ; connectors: female BNC input, male BNC output	Tektronix part number 011-0069-02	Used to Test Delta Time Measurement Accuracy, and channel isolation
28. Digital Multimeter	Ohms: <60 Ohms	Keithley 2000	Checking input impedance

¹ Wavetek 9500 with option 100 and an output head (9520, 9530, or 9550) appropriate for the bandwidth of the instrument being tested.

² For Delta Time Measurement Accuracy, use a Wavetek 9500 or a pulse generator with a rise time as shown in Table 4-7 on page 4-46.

³ On Instruments with a bandwidth ≤ 3 GHz, items 12, 13, and 14 may be replaced with a Wavetek 9500 with option 100 and a 9559 output head.

TDS6000B Test Record

Photocopy this table and use it to record the performance test results for your TDS6000B Digital Storage Oscilloscopes.

TDS6604B and TDS6804B Test Record

Instrument Serial Number: _____ Certificate Number: _____
 Temperature: _____ RH %: _____
 Date of Calibration: _____ Technician: _____

TDS6604B and TDS6804B performance test		Minimum	Incoming	Outgoing	Maximum
DC voltage measurement accuracy (averaged)					
CH1	50 mV Vert scale setting, -5 Div position setting, +0.5 V offset	+ 878.3 mV	_____	_____	+ 921.7 mV
CH1	50 mV Vert scale setting, +5 Div position setting, -0.5 V offset	- 921.7 mV	_____	_____	- 878.3 mV
CH1	100 mV Vert scale setting, -5 Div position setting, +4.8 V offset	+ 4.914 V	_____	_____	+ 5.086 V
CH1	100 mV Vert scale setting, +5 Div position setting, -4.8 V offset	- 5.086 V	_____	_____	- 4.914 V
CH1	1.0 V Vert scale setting, -5 Div position setting, +2.5 V offset	+ 4.125 V	_____	_____	+ 4.875 V
CH1	1.0 V Vert scale setting, +5 Div position setting, -2.5 V offset	- 4.875 V	_____	_____	- 4.125 V
CH2	50 mV Vert scale setting, -5 Div position setting, +0.5 V offset	+ 878.3 mV	_____	_____	+ 921.7 mV
CH2	50 mV Vert scale setting, +5 Div position setting, -0.5 V offset	- 921.7 mV	_____	_____	- 878.3 mV
CH2	100 mV Vert scale setting, -5 Div position setting, +4.8V offset	+ 4.914 V	_____	_____	+ 5.086 V
CH2	100 mV Vert scale setting, +5 Div position setting, -4.8 V offset	- 5.086 V	_____	_____	- 4.914 V
CH2	1.0 V Vert scale setting, -5 Div position setting, +2.5 V offset	+ 4.125 V	_____	_____	+ 4.875 V
CH2	1.0 V Vert scale setting, +5 Div position setting, -2.5 V offset	- 4.875 V	_____	_____	- 4.125 V

TDS6604B and TDS6804B Test Record (cont.)

Instrument Serial Number: _____ Certificate Number: _____
 Temperature: _____ RH %: _____
 Date of Calibration: _____ Technician: _____

TDS6604B and TDS6804B performance test		Minimum	Incoming	Outgoing	Maximum
CH3	50 mV Vert scale setting, -5 Div position setting, +0.5 V offset	+ 878.3 mV	_____	_____	+ 921.7 mV
CH3	50 mV Vert scale setting, +5 Div position setting, -0.5 V offset	- 921.7 mV	_____	_____	- 878.3 mV
CH3	100 mV Vert scale setting, -5 Div position setting, +4.8 V offset	+ 4.914 V	_____	_____	+ 5.086 V
CH3	100 mV Vert scale setting, +5 Div position setting, -4.8 V offset	- 5.086 V	_____	_____	- 4.914 V
CH3	1.0 V Vert scale setting, -5 Div position setting, +2.5 V offset	+ 4.125 V	_____	_____	+ 4.875 V
CH3	1.0 V Vert scale setting, +5 Div position setting, -2.5 V offset	- 4.875 V	_____	_____	- 4.125 V
CH4	50 mV Vert scale setting, -5 Div position setting, +0.5 V offset	+ 878.3 mV	_____	_____	+ 921.7 mV
CH4	50 mV Vert scale setting, +5 Div position setting, -0.5 V offset	- 921.7 mV	_____	_____	- 878.3 mV
CH4	100 mV Vert scale setting, -5 Div position setting, +4.8 V offset	+ 4.914 V	_____	_____	+ 5.086 V
CH4	100 mV Vert scale setting, +5 Div position setting, -4.8 V offset	- 5.086 V	_____	_____	- 4.914 V
CH4	1.0 V Vert scale setting, -5 Div position setting, +2.5 V offset	+ 4.125 V	_____	_____	+ 4.875 V
CH4	1.0 V Vert scale setting, +5 Div position setting, -2.5 V offset	- 4.875 V	_____	_____	- 4.125 V

TDS6604B and TDS6804B Test Record (cont.)

Instrument Serial Number: _____ Certificate Number: _____
 Temperature: _____ RH %: _____
 Date of Calibration: _____ Technician: _____

TDS6604B and TDS6804B performance test		Minimum	Incoming	Outgoing	Maximum
Offset accuracy					
CH1	50 mV Vert scale setting, +0.5 V offset 0 V offset -0.5 V offset	+ 490.0 mV - 6.5 mV - 510.0 mV	_____ _____ _____	_____ _____ _____	+ 510.0 mV + 6.5 mV - 490.0 mV
CH1	100 mV Vert scale setting, +5 V offset 0 V offset -5 V offset	+ 4.935 V - 25 mV - 5.065 V	_____ _____ _____	_____ _____ _____	+ 5.065 V + 25 mV - 4.935 V
CH1	500 mV Vert scale setting, +5 V offset 0 V offset -5 V offset	+ 4.895 V - 65 mV - 5.105 V	_____ _____ _____	_____ _____ _____	+ 5.105 V + 65 mV - 4.895 V
CH1	1.0 V Vert scale setting, +2.5 V offset 0 V offset -2.5 V offset	+ 2.365 V - 115 mV - 2.635 V	_____ _____ _____	_____ _____ _____	+ 2.635 V + 115 mV - 2.365 V
CH2	50 mV Vert scale setting, +0.5 V offset 0 V offset -0.5 V offset	+ 490.0 mV - 6.5 mV - 510.0 mV	_____ _____ _____	_____ _____ _____	+ 510.0 mV + 6.5 mV - 490.0 mV
CH2	100 mV Vert scale setting, +5 V offset 0 V offset -5 V offset	+ 4.935 V - 25 mV - 5.065 V	_____ _____ _____	_____ _____ _____	+ 5.065 V + 25 mV - 4.935 V
CH2	500 mV Vert scale setting, +5 V offset 0 V offset -5 V offset	+ 4.895 V - 65 mV - 5.105 V	_____ _____ _____	_____ _____ _____	+ 5.105 V + 65 mV - 4.895 V
CH2	1.0 V Vert scale setting, +2.5 V offset 0 V offset -2.5 V offset	+ 2.365 V - 115 mV - 2.635 V	_____ _____ _____	_____ _____ _____	+ 2.635 V + 115 mV - 2.365 V

TDS6604B and TDS6804B Test Record (cont.)

Instrument Serial Number: _____ Certificate Number: _____
 Temperature: _____ RH %: _____
 Date of Calibration: _____ Technician: _____

TDS6604B and TDS6804B performance test		Minimum	Incoming	Outgoing	Maximum
CH3	50 mV Vert scale setting, +0.5 V offset 0 V offset -0.5 V offset	+ 490.0 mV - 6.5 mV - 510.0 mV	_____ _____ _____	_____ _____ _____	+ 510.0 mV + 6.5 mV - 490.0 mV
CH3	100 mV Vert scale setting, +5 V offset 0 V offset -5 V offset	+ 4.935 V - 25 mV - 5.065 V	_____ _____ _____	_____ _____ _____	+ 5.065 V + 25 mV - 4.935 V
CH3	500 mV Vert scale setting, +5 V offset 0 V offset -5 V offset	+ 4.895 V - 65 mV - 5.105 V	_____ _____ _____	_____ _____ _____	+ 5.105 V + 65 mV - 4.895 V
CH3	1.0 V Vert scale setting, +2.5 V offset 0 V offset -2.5 V offset	+ 2.365 V - 115 mV - 2.635 V	_____ _____ _____	_____ _____ _____	+ 2.635 V + 115 mV - 2.365 V
CH4	50 mV Vert scale setting, +0.5 V offset 0 V offset -0.5 V offset	+ 490.0 mV - 6.5 mV - 510.0 mV	_____ _____ _____	_____ _____ _____	+ 510.0 mV + 6.5 mV - 490.0 mV
CH4	100 mV Vert scale setting, +5 V offset 0 V offset -5 V offset	+ 4.935 V - 25 mV - 5.065 V	_____ _____ _____	_____ _____ _____	+ 5.065 V + 25 mV - 4.935 V
CH4	500 mV Vert scale setting, +5 V offset 0 V offset -5 V offset	+ 4.895 V - 65 mV - 5.105 V	_____ _____ _____	_____ _____ _____	+ 5.105 V + 65 mV - 4.895 V
CH4	1.0 V Vert scale setting, +2.5 V offset 0 V offset -2.5 V offset	+ 2.365 V - 115 mV - 2.635 V	_____ _____ _____	_____ _____ _____	+ V + 115 mV - 2.365 V

Performance Tests

TDS6604B and TDS6804B Test Record (cont.)

Instrument Serial Number: _____ Certificate Number: _____
 Temperature: _____ RH %: _____
 Date of Calibration: _____ Technician: _____

TDS6604B and TDS6804B performance test		Minimum	Incoming	Outgoing	Maximum
Analog bandwidth					
CH1	1 V	3.535 V	_____	_____	N/A
	500 mV	2.12 V	_____	_____	N/A
	200 mV	848 mV	_____	_____	N/A
	100 mV	424 mV	_____	_____	N/A
	50 mV	212 mV	_____	_____	N/A
	20 mV	84.8 mV	_____	_____	N/A
	10 mV	42.4 mV	_____	_____	N/A
CH2	1 V	3.535 V	_____	_____	N/A
	500 mV	2.12 V	_____	_____	N/A
	200 mV	848 V	_____	_____	N/A
	100 mV	424 mV	_____	_____	N/A
	50 mV	212 mV	_____	_____	N/A
	20 mV	84.8 mV	_____	_____	N/A
	10 mV	42.4 mV	_____	_____	N/A
CH3	1 V	3.535 V	_____	_____	N/A
	500 mV	2.12 V	_____	_____	N/A
	200 mV	848 V	_____	_____	N/A
	100 mV	424 mV	_____	_____	N/A
	50 mV	212 mV	_____	_____	N/A
	20 mV	84.8 mV	_____	_____	N/A
	10 mV	42.4 mV	_____	_____	N/A
CH4	1 V	3.535 V	_____	_____	N/A
	500 mV	2.12 V	_____	_____	N/A
	200 mV	848 V	_____	_____	N/A
	100 mV	424 mV	_____	_____	N/A
	50 mV	212 mV	_____	_____	N/A
	20 mV	84.8 mV	_____	_____	N/A
	10 mV	42.4 mV	_____	_____	N/A

TDS6604B and TDS6804B Test Record (cont.)

Instrument Serial Number: _____ Certificate Number: _____
 Temperature: _____ RH %: _____
 Date of Calibration: _____ Technician: _____

TDS6604B and TDS6804B performance test		Minimum	Incoming	Outgoing	Maximum
Digitally enhanced bandwidth					
CH1	1 V	3.535 V	_____	_____	N/A
	500 mV	2.12 V	_____	_____	N/A
	200 mV	848 mV	_____	_____	N/A
	100 mV	424 mV	_____	_____	N/A
	50 mV	212 mV	_____	_____	N/A
	20 mV	84.8 mV	_____	_____	N/A
	10 mV	42.4 mV	_____	_____	N/A
CH2	1 V	3.535 V	_____	_____	N/A
	500 mV	2.12 V	_____	_____	N/A
	200 mV	848 V	_____	_____	N/A
	100 mV	424 mV	_____	_____	N/A
	50 mV	212 mV	_____	_____	N/A
	20 mV	84.8 mV	_____	_____	N/A
	10 mV	42.4 mV	_____	_____	N/A
CH3	1 V	3.535 V	_____	_____	N/A
	500 mV	2.12 V	_____	_____	N/A
	200 mV	848 V	_____	_____	N/A
	100 mV	424 mV	_____	_____	N/A
	50 mV	212 mV	_____	_____	N/A
	20 mV	84.8 mV	_____	_____	N/A
	10 mV	42.4 mV	_____	_____	N/A
CH4	1 V	3.535 V	_____	_____	N/A
	500 mV	2.12 V	_____	_____	N/A
	200 mV	848 V	_____	_____	N/A
	100 mV	424 mV	_____	_____	N/A
	50 mV	212 mV	_____	_____	N/A
	20 mV	84.8 mV	_____	_____	N/A
	10 mV	42.4 mV	_____	_____	N/A

TDS6604B and TDS6804B Test Record (cont.)

Instrument Serial Number: _____ Certificate Number: _____
 Temperature: _____ RH %: _____
 Date of Calibration: _____ Technician: _____

TDS6604B and TDS6804B performance test	Minimum	Incoming	Outgoing	Maximum
Delay between channels	N/A	_____	_____	30 ps
Channel isolation 1.5 GHz				
100 mV				
CH 1	N/A	_____	_____	0.125 divisions
CH 2	N/A	_____	_____	0.125 divisions
CH 3	N/A	_____	_____	0.125 divisions
CH 4	N/A	_____	_____	0.125 divisions
50 mV				
CH 1	N/A	_____	_____	0.125 divisions
CH 2	N/A	_____	_____	0.125 divisions
CH 3	N/A	_____	_____	0.125 divisions
CH 4	N/A	_____	_____	0.125 divisions
10 mV				
CH 1	N/A	_____	_____	0.125 divisions
CH 2	N/A	_____	_____	0.125 divisions
CH 3	N/A	_____	_____	0.125 divisions
CH 4	N/A	_____	_____	0.125 divisions
full bandwidth				
100 mV				
CH 1	N/A	_____	_____	0.5 divisions
CH 2	N/A	_____	_____	0.5 divisions
CH 3	N/A	_____	_____	0.5 divisions
CH 4	N/A	_____	_____	0.5 divisions
50 mV				
CH 1	N/A	_____	_____	0.5 divisions
CH 2	N/A	_____	_____	0.5 divisions
CH 3	N/A	_____	_____	0.5 divisions
CH 4	N/A	_____	_____	0.5 divisions
10 mV				
CH 1	N/A	_____	_____	0.5 divisions
CH 2	N/A	_____	_____	0.5 divisions
CH 3	N/A	_____	_____	0.5 divisions
CH 4	N/A	_____	_____	0.5 divisions

TDS6604B and TDS6804B Test Record (cont.)

Instrument Serial Number: _____ Certificate Number: _____
 Temperature: _____ RH %: _____
 Date of Calibration: _____ Technician: _____

TDS6604B and TDS6804B performance test		Minimum	Incoming	Outgoing	Maximum
Input impedance					
	CH1 10 mV	48.75 Ω	_____	_____	51.25 Ω
	CH1 100 mV	48.75 Ω	_____	_____	51.25 Ω
	CH2 10 mV	48.75 Ω	_____	_____	51.25 Ω
	CH2 100 mV	48.75 Ω	_____	_____	51.25 Ω
	CH3 10 mV	48.75 Ω	_____	_____	51.25 Ω
	CH3 100 mV	48.75 Ω	_____	_____	51.25 Ω
	CH4 10 mV	48.75 Ω	_____	_____	51.25 Ω
	CH4 100 mV	48.75 Ω	_____	_____	51.25 Ω
Time base system					
Long term sample rate, delay time, and internal reference accuracy		9999.975 kHz	_____	_____	10000.025 kHz
Delta time measurement	Ch 1	N/A	_____	_____	≤ 0.03 ns
	Ch 2	N/A	_____	_____	≤ 0.03 ns
	Ch 3	N/A	_____	_____	≤ 0.03 ns
	Ch 4	N/A	_____	_____	≤ 0.03 ns
Trigger system accuracy					
Time accuracy for pulse, glitch, timeout, and Width, Hor. scale ≤ 1 μ s					
	Lower Limit	3.5 ns	_____	_____	6.5 ns
	Upper Limit	3.5 ns	_____	_____	6.5 ns
Time accuracy for pulse, glitch, timeout, and width, Hor. scale > 1 μ s					
	Lower Limit	1.9 μ s	_____	_____	2.1 μ s
	Upper Limit	1.9 μ s	_____	_____	2.1 μ s
Probe compensation output signal					
Frequency		950 Hz	_____	_____	1.050 kHz
Voltage (difference)		300 mV	_____	_____	450 mV

TDS6604B and TDS6804B Test Record (cont.)

Instrument Serial Number: _____ Certificate Number: _____
 Temperature: _____ RH %: _____
 Date of Calibration: _____ Technician: _____

TDS6604B and TDS6804B performance test	Minimum	Incoming	Outgoing	Maximum
Serial trigger (Option ST only)				
Baud rate limits				
Serial word recognizer				
Signal path 0, Pattern matching 1				
Trigger 1 UI before 0	Pass	_____	_____	N/A
Trigger on 0	Pass	_____	_____	N/A
Trigger 1 UI after 0	Pass	_____	_____	N/A
Signal path 1, Pattern matching 1				
Trigger 1 UI before 1	Pass	_____	_____	N/A
Trigger on 1	Pass	_____	_____	N/A
Trigger 1 UI after 1	Pass	_____	_____	N/A
Pattern matching 0				
Position 1	Pass	_____	_____	N/A
Position 2	Pass	_____	_____	N/A
Position 3	Pass	_____	_____	N/A
Position 4	Pass	_____	_____	N/A
Position 5	Pass	_____	_____	N/A
Position 6	Pass	_____	_____	N/A
Position 7	Pass	_____	_____	N/A
Position 8	Pass	_____	_____	N/A
Position 9	Pass	_____	_____	N/A
Position 10	Pass	_____	_____	N/A
Position 11	Pass	_____	_____	N/A
Position 12	Pass	_____	_____	N/A
Position 13	Pass	_____	_____	N/A
Position 14	Pass	_____	_____	N/A
Position 15	Pass	_____	_____	N/A
Position 16	Pass	_____	_____	N/A
Position 17	Pass	_____	_____	N/A
Position 18	Pass	_____	_____	N/A
Position 19	Pass	_____	_____	N/A
Position 20	Pass	_____	_____	N/A
Position 21	Pass	_____	_____	N/A
Position 22	Pass	_____	_____	N/A
Position 23	Pass	_____	_____	N/A
Position 24	Pass	_____	_____	N/A
Position 25	Pass	_____	_____	N/A
Position 26	Pass	_____	_____	N/A
Position 27	Pass	_____	_____	N/A
Position 28	Pass	_____	_____	N/A
Position 29	Pass	_____	_____	N/A
Position 30	Pass	_____	_____	N/A
Position 31	Pass	_____	_____	N/A
Position 32	Pass	_____	_____	N/A
Clock recovery frequency range	Pass	_____	_____	N/A

Signal Acquisition System Checks

These procedures check those characteristics that relate to the signal-acquisition system and are listed as checked under *Warranted Characteristics* in *Specifications*. Refer to Table 4-1 on page 4-2 for test equipment specifications.

Check DC Voltage Measurement Accuracy

Equipment required	Two dual-banana connectors (Item 5) One BNC T connector (Item 6) One DC calibration generator (Item 9) One SMA male-to-female BNC adapter (Item 20) Two precision 50 Ω coaxial cables (Item 4)
Prerequisites	The oscilloscope must meet the prerequisites listed on page 4-1



WARNING. The generator is capable of outputting dangerous voltages. Be sure to set the DC calibration generator to off or 0 volts before connecting, disconnecting, and/or moving the test hookup during the performance of this procedure. Also, check that the calibrator does not have shorting straps installed between the DC and sense outputs or grounds.

1. Install the test hookup and preset the instrument controls:
 - a. Hook up the test-signal source:
 - Set the output of a DC calibration generator to off or 0 volts.
 - Connect the output of a DC calibration generator through a dual-banana connector followed by a 50 Ω precision coaxial cable to one side of a BNC T connector. See Figure 4-1.
 - Connect the Sense output of the generator through a second dual-banana connector followed by a 50 Ω precision coaxial cable to the other side of the BNC T connector. Now connect the BNC T connector to **CH 1** through an adapter. See Figure 4-1.

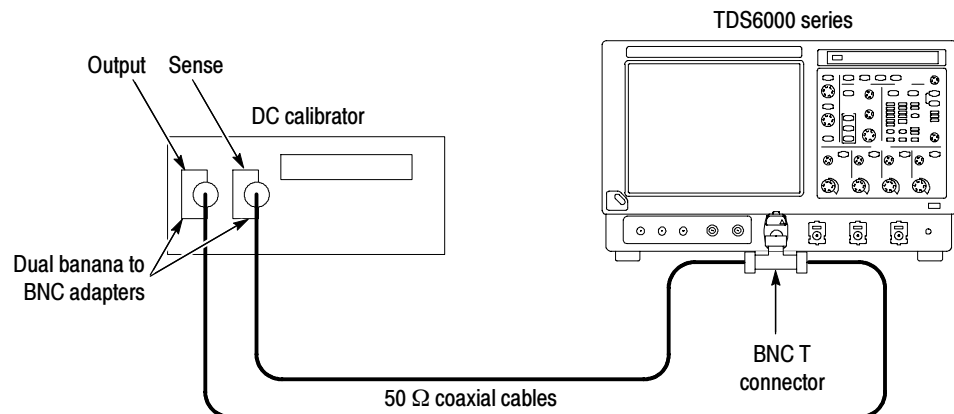

Figure 4- 1: Initial test hookup

- b. *Initialize the oscilloscope:* Press **DEFAULT SETUP**.
 - c. *Modify the default settings:*
 - From the toolbar, touch **Horiz** and select the **Acquisition** tab.
 - Touch **Average** and set the number of averages to **16**.
2. *Confirm input channels are within limits for DC accuracy at maximum offset and position:* Do the following substeps — test CH 1 first, *skipping substep 2a since CH 1 is already selected from step 1.*
- a. *Select an unchecked channel:*
 - From the toolbar, touch **MEAS** and then **Clear** to remove the previous measurement.
 - Press the Vertical button of the channel just confirmed to remove the channel from the display.
 - Press the front-panel Vertical button that corresponds to the channel you are to confirm.
 - *Set the generator output to 0 V.*
 - Move the test hookup to the channel you selected.
 - b. *Turn on the measurement Mean for the channel:*
 - From the toolbar, touch **MEAS** and select the **Ampl** tab, then touch **Mean** to measure the mean of the current channel.
 - Touch **Close**.

- c. *Set the vertical scale:* Set the vertical **SCALE** to one of the settings listed in Table 4-2 that is not yet checked. (Start with the first setting listed).

Table 4-2: DC Voltage measurement accuracy

Scale setting	Position setting (Divs)	Offset setting ¹	Generator setting	Accuracy limits
50 mV	-5	+0.5 V	+900 mV	+878.3 mV to +921.7 mV
	+5	-0.5 V	-900 mV	-921.7 mV to -878.3 mV
100 mV	-5	+4.8 V	+5.0 V	+4.914 V to 5.086 V
	+5	-4.8 V	-5.0 V	-5.086 V to -4.914 V
1 V	-5	+2.5 V	+4.5 V	+4.125 V to 4.875 V
	+5	-2.5 V	-4.5 V	-4.875 V to -4.125 V

¹ Set as precisely as the instrument's offset resolution permits.

- d. *Display the test signal:*
- From the toolbar touch **VERT** and touch **Position**.
 - Use the keypad to set vertical position to -5 divisions (touch **CLR**, **5**, **-**, and then **ENTER**, on the keypad). The baseline level will move off screen.
 - Touch **Offset**.
 - Use the keypad to set vertical offset to the positive-polarity setting listed in the table for the current vertical scale setting. The baseline level will remain off screen.
 - Set the generator to the level and polarity indicated in the table for the vertical scale, position, and offset settings that you have made. The DC test level should appear on screen. (If it doesn't return, the DC accuracy check has failed for the current vertical scale setting of the current channel).
- e. *Measure the test signal:* Touch **Close**. Read the measurement results at the **Mean** measurement readout. See Figure 4-2.

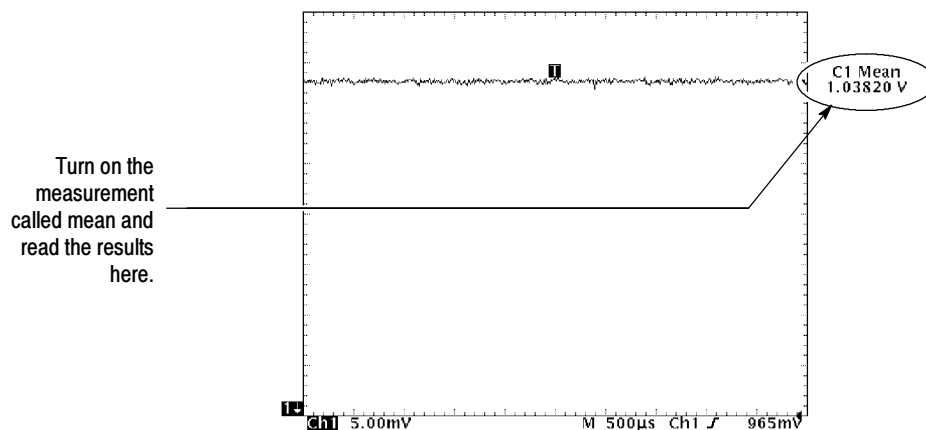

Figure 4-2: Measurement of DC accuracy at maximum offset and position

f. *Check against limits:*

- CHECK that the readout for the measurement **Mean** readout on screen is within the limits listed for the current vertical scale and position/offset/generator settings. Enter value on test record.
- Repeat substep d, reversing the polarity of the position, offset, and generator settings as is listed in the table.
- CHECK that the **Mean** measurement readout on screen is within the limits listed for the current vertical scale setting and position/offset/generator settings. Enter value on test record.
- Repeat substeps c through f until all vertical scale settings, listed in Table 4-2, are checked for the channel under test.

g. *Test all channels:* Repeat substeps a through f for all four channels.

3. *Disconnect the hookup:*

- a.** *Set the generator output to 0 V.*
- b.** Disconnect the cable and adapter from the generator output and the input connector of the channel last tested.

Check Offset Accuracy

Equipment required	Two dual-banana connectors (Item 5) One BNC T connector (Item 6) One DC calibration generator (Item 9) One SMA male-to-female BNC adapter (Item 20) Two precision 50 Ω coaxial cables (Item 4)
Prerequisites	The oscilloscope must meet the prerequisites listed on page 4-1



WARNING. The generator is capable of outputting dangerous voltages. Be sure to set the DC calibration generator to off or 0 volts before connecting, disconnecting, and/or moving the test hookup during the performance of this procedure. Also, check that the calibrator does not have shorting straps installed between the DC and sense outputs or grounds.

1. Install the test hookup and preset the instrument controls:

a. Hook up the test-signal source:

- Set the output of a DC calibration generator to off or 0 volts.
- Connect the output of a DC calibration generator through a dual-banana connector followed by a 50 Ω precision coaxial cable to one side of a BNC T connector. See Figure 4-3.
- Connect the Sense output of the generator through a second dual-banana connector followed by a 50 Ω precision coaxial cable to the other side of the BNC T connector. Now connect the BNC T connector to **CH 1** through an adapter. See Figure 4-3.

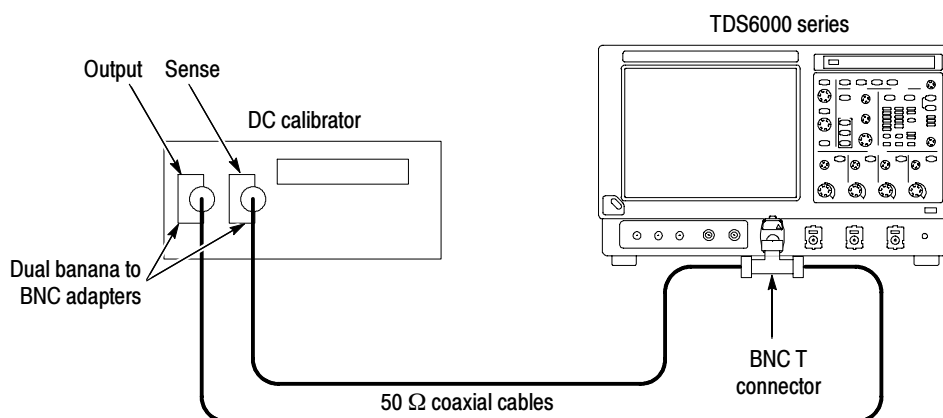

Figure 4-3: Initial test hookup

- b. *Initialize the oscilloscope:* Press **DEFAULT SETUP**.
 - c. *Modify the default settings:*
 - From the toolbar, touch **Horiz** and select the **Acquisition** tab.
 - Touch **Average** and set the number of averages to **16**.
2. *Confirm input channels are within limits for DC accuracy at maximum offset and position:* Do the following substeps — test CH 1 first, *skipping substep 2a since CH 1 is already selected from step 1.*
- a. *Select an unchecked channel:*
 - From the toolbar, touch **MEAS** and then **Clear** to remove the previous measurement.
 - Press the Vertical button of the channel just confirmed to remove the channel from the display.
 - Press the front-panel **VERT** button that corresponds to the channel you are to confirm.
 - *Set the generator output to 0 V.*
 - Move the test hookup to the channel you selected.
 - b. *Turn on the measurement Mean for the channel:*
 - From the toolbar, touch **MEAS** and select the **Ampl** tab, then touch **Mean** to measure the mean of the current channel.
 - Touch **Close**.
 - c. *Set the vertical scale:* Set the vertical **SCALE** to one of the settings listed in Table 4-3 that is not yet checked. (Start with the first setting listed).

Table 4-3: Offset accuracy

Scale setting	Position setting (Divs)	Offset setting ¹	Generator setting	Accuracy limits
50 mV	0	+0.5 V	+500 mV	+490.0 mV to +510.0 mV
		0 V	0.0 mV	-6.5 mV to +6.5 mV
		-0.5 V	-500 mV	-510.0 mV to -490.0 mV
100 mV	0	+5 V	+5.0 V	+4.935 V to +5.065 V
		0 V	0.0 V	-25 mV to +25 mV
		-5 V	-5.0 V	-5.065 V to -4.935 V

Table 4-3: Offset accuracy (Cont.)

Scale setting	Position setting (Divs)	Offset setting ¹	Generator setting	Accuracy limits
500 mV	0	+5 V	+5.0 V	+4.895 V to +5.105 V
		0 V	0.0 V	-65 mV to +65 mV
		-5 V	-5.0 V	-5.105 V to -4.895 V
1 V	0	+2.5 V	+2.5 V	+2.365 V to +2.635 V
		0 V	0.0 V	-115 mV to +115 mV
		-2.5 V	-2.5 V	-2.635 V to -2.365 V

¹ Set as precisely as the instrument's offset resolution permits.

d. *Display the test signal:*

- From the toolbar touch **VERT** and then touch **Position**.
- Use the keypad to set vertical position to 0.0 divisions (press **CLR** and then **ENTER**, on the keypad).
- Touch **Offset**.
- Use the keypad to set vertical offset to the positive-polarity setting listed in the table for the current vertical scale setting. The baseline level may move off screen.
- Set the generator to the level and polarity indicated in the table for the vertical scale, position, and offset settings that you have made. The DC test level should appear on screen. (If it doesn't return, the offset accuracy check has failed for the current vertical scale setting of the current channel).

e. *Measure the test signal:* Touch **Close**. Read the measurement results at the **Mean** measurement readout. See Figure 4-4.

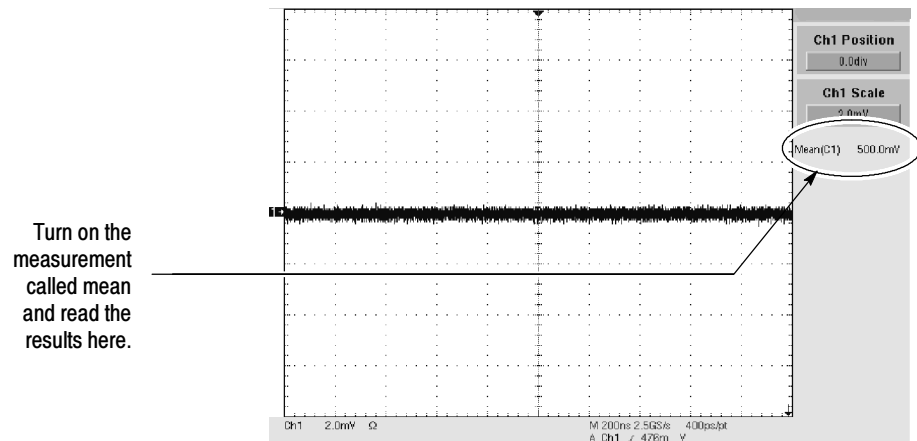

Figure 4-4: Measurement of offset accuracy

f. Check against limits:

- CHECK that the readout for the measurement **Mean** readout on screen is within the limits listed for the current vertical scale and position/offset/generator settings. Enter value on test record.
- Repeat substep d, using the zero offset and generator settings as is listed in the table.
- CHECK that the **Mean** measurement readout on screen is within the limits listed for the current vertical scale setting and position/offset/generator settings. Enter value on test record.
- Repeat substep d, using the negative-polarity offset and generator settings as is listed in the table.
- CHECK that the **Mean** measurement readout on screen is within the limits listed for the current vertical scale setting and position/offset/generator settings. Enter value on test record.
- Repeat substeps c through f until all vertical scale settings, listed in Table 4-3, are checked for the channel under test.

g. Test all channels: Repeat substeps a through f for all four channels.

3. Disconnect the hookup:

- a. Set the generator output to 0 V.**
- b. Disconnect the cable and adapter from the generator output and the input connector of the channel last tested.**

Check Maximum Input Voltage

Equipment required	Two dual-banana connectors (Item 5) One BNC T connector (Item 6) One 10X attenuator (Item 1) One DC calibration generator (Item 9) One SMA male-to-female BNC adapter (Item 20) Two precision 50 Ω coaxial cables (Item 4)
Prerequisites	The oscilloscope must meet the prerequisites listed on page 4-1



WARNING. *The generator is capable of outputting dangerous voltages. Be sure to set the DC calibration generator to off or 0 volts before connecting, disconnecting, and/or moving the test hookup during the performance of this procedure. Also, check that the calibrator does not have shorting straps installed between the DC and sense outputs or grounds.*

1. *Install the test hookup and preset the instrument controls:*

a. *Hook up the test-signal source:*

- Set the output of a DC calibration generator to off or 0 volts.
- Connect the output of a DC calibration generator through a dual-banana connector followed by a 50 Ω precision coaxial cable to one side of a BNC T connector. See Figure 4-5.
- Connect the Sense output of the generator through a second dual-banana connector followed by a 50 Ω precision coaxial cable to the other side of the BNC T connector. Now connect the BNC T connector to **CH 1** through a 10X attenuator and an adapter. See Figure 4-5.

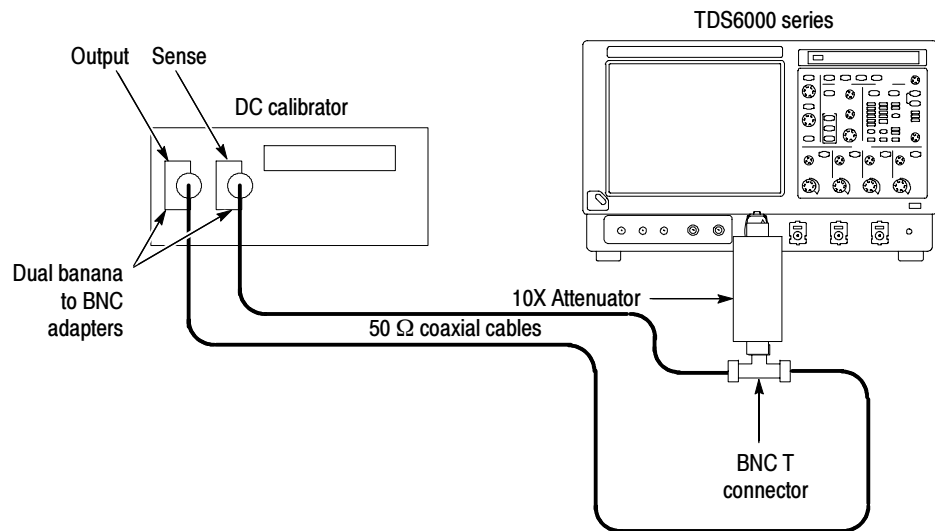

Figure 4-5: Initial test hookup

- b. *Initialize the oscilloscope:* Press **DEFAULT SETUP**.
 - c. *Modify the default settings:*
 - From the toolbar, touch **Horiz** and select the **Acquisition** tab.
 - Touch **Average** and set the number of averages to **16**.
2. *Confirm input channels are within limits for maximum input voltage:* Do the following substeps — test CH 1 first, skipping substep 2a since CH 1 is already selected from step 1.
 - a. *Select an unchecked channel:*
 - From the toolbar, touch **MEAS** and then **Clear** to remove the previous measurement.
 - Press the Vertical button of the channel just confirmed to remove the channel from the display.
 - Press the front-panel Vertical button that corresponds to the channel you are to confirm.
 - *Set the generator output to 0 V.*
 - Move the test hookup to the channel you selected.
 - b. *Turn on the measurement High for the channel:*
 - From the toolbar, touch **MEAS** and select the Ampl tab, then touch **High** to measure the high of the current channel.

- Touch **Close**.
- c. *Set the vertical scale:*
- Set the vertical **SCALE** to one of the settings listed in Table 4-4 that is not yet checked. (Start with the first setting listed).
 - From the toolbar touch **VERT** and touch **Position**.
 - Use the keypad to set vertical position to -3 divisions (press **CLR**, **3**, **-**, and then **ENTER**, on the keypad).
 - Set the Coupling to **DC**.
 - Touch **Offset**.
 - Use the keypad to set vertical offset to 0 V.
 - Touch **Close**.

Table 4-4: Maximum input voltage limit

Scale setting	Position setting (Divs)	Offset setting	Generator setting	Readout with 10X attenuator	Limits (without 10X attenuator)
50 mV	-3	0 V	+1 V	+100 mV	Coupling in CH readout stays Ω
			+3 V	+300 mV	Coupling changes to ground
1 V	-3	0 V	+5 V	+500 mV	Coupling in CH readout stays Ω
			+10 V	+1.0 V	Coupling changes to ground

- d. *Display the test signal:* Set the generator to the level and polarity indicated in the table for the vertical scale, position, and offset settings that you have made, or set the generator for the readout indicated in the table for the vertical scale, position, and offset settings that you have made. See Figure 4-6.

NOTE. When setting the Wavetek to output 10 V, use the following procedure:

Press the **Aux** button

Press the fourth soft key down (Selects the pulse with an exclamation point)

Set the amplitude to 10 V

Press the **->|** key to select the pulse energy

Set the energy to 50J

Press the Output **On** key

Press the **Trig Pulse** soft key to trigger the pulse (this will generate a 10 V pulse with 25 seconds duration).

Use the normal DC output for the 1 V, 3 V, and 5 V generator settings.

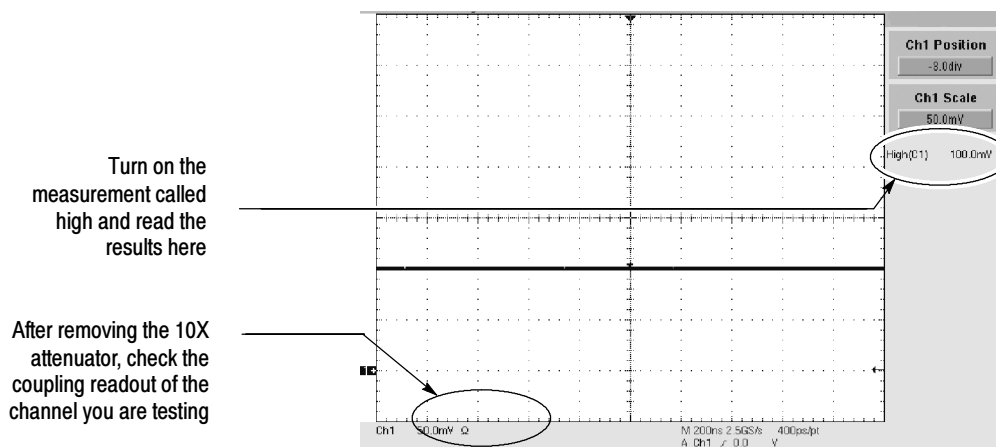

Figure 4-6: Check of maximum input voltage

e. Check an unchecked generator setting against limits:

- Remove the 10X attenuator.
- Connect the generator signal directly to the oscilloscope.
- CHECK that the coupling readout on screen for the selected channel is as listed for the current vertical scale and position/offset/generator settings.
- Reinstall the 10X attenuator.

f. Check the next generator setting: Repeat substeps d and e, using the new generator setting as is listed in the table.

g. Check the remaining vertical scale settings: Repeat substeps c through f until all vertical scale settings, listed in Table 4-4, are checked for the channel under test.

- h. *Test all channels:* Repeat substeps a through g for all vertical channels.
3. *Disconnect the hookup:*
 - a. *Set the generator output to 0 V.*
 - b. Disconnect the cable, attenuator, and adapter from the generator output and the input connector of the channel last tested.

Check Analog Bandwidth

Equipment required	One sine wave generator (Item 12) One level meter and power sensor (Item 13) One power splitter (Item 14) One male N to male SMA adapter (Item 17) Four male N to female BNC adapters (Item 15) One SMA female to SMA female cable (Item 22) Attenuators (Items 1 and 2) One SMA male-to-female BNC adapter (Item 20)
Prerequisites	See page 4-1

1. *Install the test hookup and preset the instrument controls:*
 - a. *Initialize the oscilloscope:*
 - Press **DEFAULT SETUP**.
 - b. *Modify the default settings:*
 - Turn the horizontal **SCALE** knob to 40 ns.
 - From the toolbar, touch **Horiz** and select the **Acquisition** tab.
 - Touch **Average** and set the number of averages to 16.
 - Set Sampling mode to ET (Equivalent Time).
 - From the toolbar, touch **MEAS**. Touch Setup **Ref Levs**; then touch **Min-Max** button.
 - TDS6804 Only: From the toolbar, touch **VERT** and select **Bandwidth Enhanced** then touch **AUTO** and **All CHANNELS at Enhanced 20 GS/s**.

NOTE. The sine wave generator output amplitude must be leveled to within 0.35 db of the reference frequency (10 MHz) through the bandwidth frequency listed in Table 4-5 on page 4-27. The 0.35 db requirement is necessary to ensure a bandwidth that meets Tektronix specifications.

You can perform bandwidth PV using an unlevelled sine wave generator (with amplitude error > 0.35 db). Under these conditions, the bandwidth PV is subject to the flatness errors associated with the generator used.

Refer to the Sine Wave Generator Leveling Procedure on page 4-73 if your sine wave generator does not have automatic output amplitude leveling.

- c. *Hook up the test-signal source:* Connect the sine wave output of a leveled sine wave generator to **CH 1**. Set the output of the generator to a reference frequency of 50 MHz or less. See Figure 4-7.

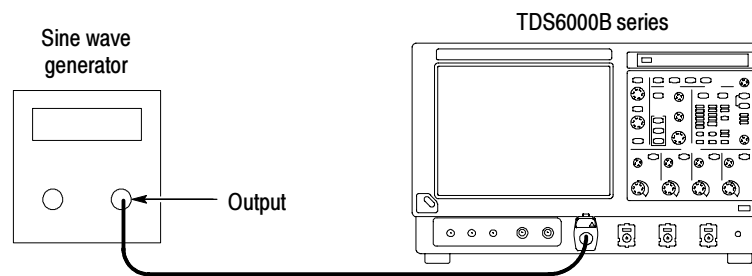

Figure 4-7: Initial test hookup

2. *Confirm the input channels are within limits for analog bandwidth:* Do the following substeps — test CH 1 first, *skipping substeps a and b since CH 1 is already set up for testing from step 1.*
 - a. *Select an unchecked channel:*
 - From the toolbar, touch **MEAS** and then **Clear** to remove all previous measurements.
 - Press the **VERT** button of the channel just confirmed to remove the channel from the display.
 - Press the front-panel **VERT** button that corresponds to the channel you are to confirm.
 - Move the leveled output of the sine wave generator to the channel you selected.

- b. *Match the trigger source to the channel selected:* Press the Trigger **SOURCE** button until the source that corresponds to the channel you are to confirm is on.
- c. *Set the vertical scale:* Set the vertical **SCALE** that corresponds to the channel you are to confirm to one of the settings listed in Table 4-5 not yet checked. (Start with the 100 mV setting).
- d. *Set the triggering coupling:* Touch the Coupling **DC** button.

Table 4-5: Analog bandwidth

Vertical scale	Reference amplitude (6 divisions)	Horizontal scale	Test frequency		Limits
			TDS6604B	TDS6804B	-3 dB Limits
10 mV	60 mV	200 ps	6 GHz	8 GHz	≥42.4 mV
20 mV	120 mV	200 ps	6 GHz	8 GHz	≥84.8 mV
50 mV	300 mV	200 ps	6 GHz	8 GHz	≥212 mV
100 mV	600 mV	200 ps	6 GHz	8 GHz	≥424 mV
200 mV	1.2 V	200 ps	6 GHz	8 GHz	≥848 mV
500 mV	3 V ¹	200 ps	6 GHz	8 GHz	≥2.12 V ¹
1 V	5 V ¹	200 ps	6 GHz	8 GHz	≥3.535 V ¹

¹ If your generator cannot output the required amplitude, determine its maximum output at the Test frequency, and use this for the reference amplitude. The -3 db limit can be calculated as: $0.707 \times \text{reference amplitude}$.

- e. *Display the test signal:* Do the following subparts to first display the reference signal and then the test signal.
 - From the toolbar touch **MEAS**; then select the **Time** tab.
 - Touch the **Freq** button to measure the frequency of the current channel.
 - Select the **Ampl** tab. Touch the **Pk-Pk** button.
 - Touch **Close** button.
 - Set the generator output so the CHx Pk-Pk readout equals the reference amplitude in Table 4-5 that corresponds to the vertical scale set in substep c.
 - Press the front-panel **PUSH TO SET 50%** as necessary to trigger a stable display. At full bandwidth, you may also want to make small, manual adjustments to the trigger level. You can use the **Trigger LEVEL** knob to do this.

f. *Measure the test signal:*

- Set the frequency of the generator, as shown on screen, to the test frequency in Table 4-5 that corresponds to the vertical scale set in substep c. See Figure 4-8.
- Set the horizontal **SCALE** to the horizontal scale setting in Table 4-5 that corresponds to the vertical scale set in substep c. Press **PUSH TO SET 50%** as necessary to trigger the signal.
- Read the results at the CHx Pk-Pk readout, which will automatically measure the amplitude of the test signal. See Figure 4-8.

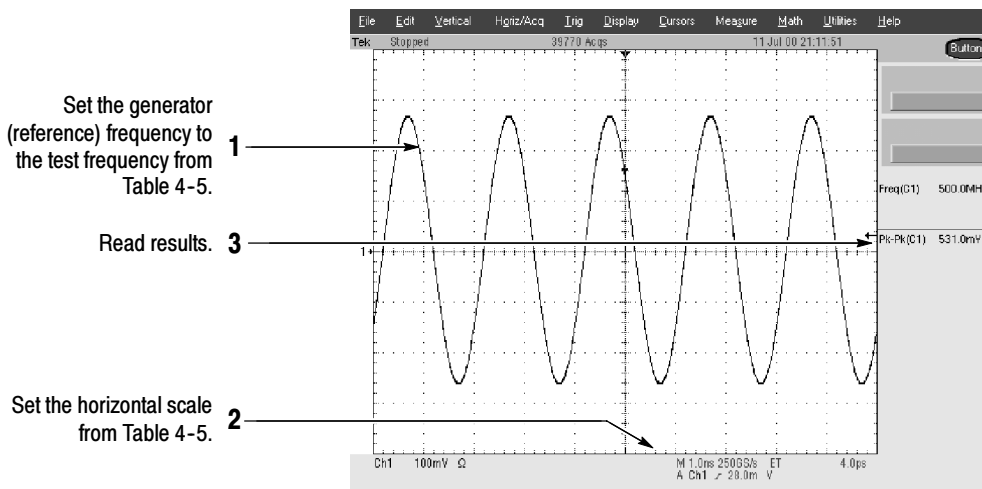

Figure 4-8: Measurement of analog bandwidth

g. *Check against limits:*

- CHECK that the **Pk-Pk** readout on screen is within the limits listed in Table 4-5 for the current vertical scale setting.
- Enter voltage on the test record.
- When finished checking, set the horizontal **SCALE** back to the 40 ns setting.

STOP. *Checking each channel's bandwidth at all vertical scale settings is time consuming and unnecessary. You may skip checking the remaining vertical scale settings in Table 4-5 (that is, skip the following substep, h) if this oscilloscope has performed as follows:*

- Passed the 100 mV vertical scale setting just checked in this procedure.
- Passed the *Verify Internal Adjustment, Self Compensation, and Diagnostics* procedure found under *Self Tests*, on page 3-1.

NOTE. *Passing the signal path compensation confirms the signal path for all vertical scale settings for all channels. Passing the internal diagnostics ensures that the factory-set adjustment constants that control the bandwidth for each vertical scale setting have not changed.*

h. *Check remaining vertical scale settings against limits (optional):*

- If desired, finish checking the remaining vertical scale settings for the channel under test by repeating substeps c through g for each of the remaining scale settings listed in Table 4-5 for the channel under test.
- When doing substep e, skip the subparts that turn on the CHx Pk-Pk measurement until you check a new channel.
- Before doing substep f, touch the **Clear** button to remove the previous channel measurements.
- Install/remove attenuators between the generator leveled output and the channel input as needed to obtain the six division reference signals listed in the table.
- When finished bandwidth checks for a particular channel, clear all measurements for that channel.

i. *Test all channels:* Repeat substeps a through g for all four channels.

- 3.** *Disconnect the hookup:* Disconnect the test hook up from the input connector of the channel last tested.

Check Delay Between Channels

Equipment required	One sine wave generator (Item 12) Three precision 50 Ω coaxial cables (Item 4) One power splitter (Item 14) or power divider (item 7) 3 SMA female-to-female adapter connector (Item 18) 3 SMA male-to-female BNC adapter connector (Item 19) Two SMA male-to-female BNC adapter (Item 20)
Prerequisites	See page 4-1

STOP. *DO NOT* use the vertical position knob to reposition any channel while doing this check. To do so invalidates the test.

1. *Install the test hookup and preset the instrument controls:*
 - a. *Initialize the front panel:* Press the **DEFAULT SETUP** button.
 - b. *Modify the initialized front-panel control settings:*
 - Do *not* adjust the vertical position of any channel during this procedure.
 - Set the horizontal **SCALE** to 500 ps.
 - From the toolbar, touch **Horiz** and select the **Acquisition** tab.
 - Touch **Average** and set the number of averages to **16**.
 - c. *Hook up the test-signal source:*
 - Connect the sine wave output of a sine wave generator to a 50 Ω precision coaxial cable followed by a power splitter.
 - Connect the power splitter to both **CH 1** and **CH 2**. See Figure 4-9.

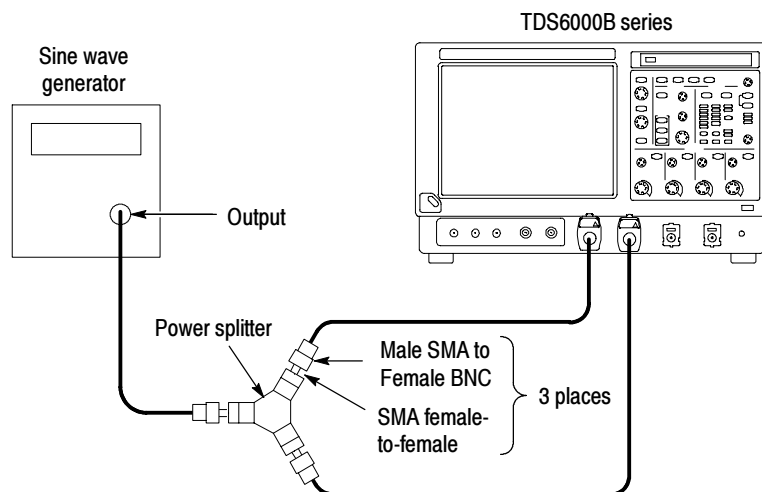

Figure 4-9: Initial test hookup

2. *Confirm all four channels are within limits for channel delay:*
 - a. *Set up the generator:* Set the generator frequency to 500 MHz and the amplitude for six to eight divisions in CH 1.

Hint: As you are adjusting the generator amplitude, push **PUSH TO SET 50%** frequently to speed up the updating of the waveform amplitude on screen.

- b. The horizontal **SCALE** should already be set to 500 ps. Now set it to 125 ps.
- c. *Save a CH 2 waveform:* Press the **CH 2** Vertical button. From the toolbar, touch the **Refs** button and select the **Ref 2** tab. Touch the Save Wfm to Ref2 **Save** button.
- d. *Save CH 3 waveform:*
 - Move the power splitter from **CH 2** to **CH 3**, so that **CH 1** and **CH 3** are driven. Press the Vertical **CH 2** and **CH 3** buttons. Select the **Ref 3** tab and touch the Ch Channel **3** button. Touch the Save Wfm to Ref3 **Save** button.
- e. *Display all test signals:*
 - Press the **CH 3** Vertical button to remove CH 3 from the display.
 - Display the live waveform. Move the power splitter from **CH 3** to **CH 4**, so that CH 1 and CH 4 are driven. Press the Vertical **CH 4** button to display. See Figure 4-10 on page 4-32.
 - Display the reference waveforms. To do this, touch the Ref 3 Display **Off** button to toggle it to On and display the reference. Select the **Ref 2** tab and touch the Display **Off** button to toggle it to On. You may notice their overlapping waveform handle icons. See Figure 4-10 on page 4-32.
- f. *Measure the test signal:*
 - Locate the time reference points for these waveforms. Do this by first identifying the point where the rising edge of the left-most waveform crosses the center horizontal graticule line. Next, note the corresponding *time reference point* for the right-most waveform. See Figure 4-10 on page 4-32.
 - Press **CURSORS** and select the **V Bars** Cursors Type.
 - Touch the **Close** button.

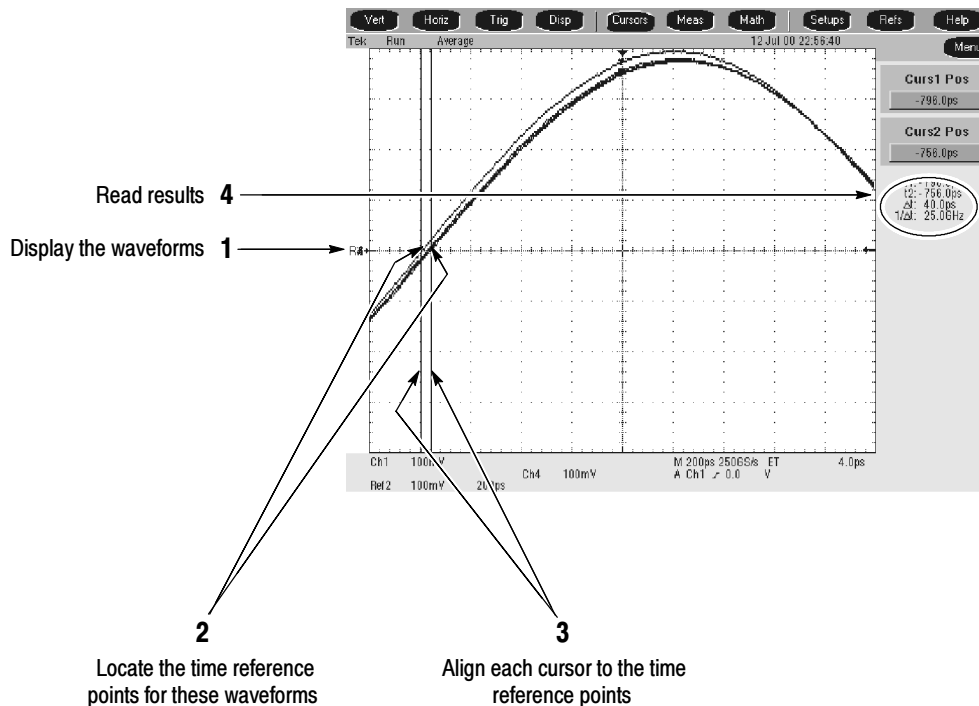

Figure 4-10: Measurement of channel delay

- g. *Check against limits:* Use the cursors to measure the skew from CH 1 to CH 2, CH 1 to CH 3, and CH 1 to CH 4. Write down these three numbers in the first measurement column of Table 4-6. Note that these numbers may be either positive or negative.
- h. Move the power splitter on CH 1 to CH 2. Move the power splitter on CH 4 to CH 1.

NOTE. To eliminate errors caused by cables and adapters, the measurements are repeated and averaged after swapping channel position of cables.

- i. Repeat the procedure from step 2.c through 2.e.
- j. Again use the cursors to measure the skew from CH 1 to CH 2, CH 1 to CH 3, and CH 1 to CH 4. Write down these numbers in the second measurement column of Table 4-6. Note that these numbers may be either positive or negative.
- k. Add the first CH 1 to CH 2 skew measurement to the second CH 1 to CH 2 skew measurement and divide the result by 2. Use Table 4-6.

- l. Add the first CH 1 to CH 3 skew measurement to the second CH 1 to CH 3 skew measurement and divide the result by 2. Use Table 4-6.
- m. Add the first CH 1 to CH 4 skew measurement to the second CH 1 to CH 4 skew measurement and divide the result by 2. Use Table 4-6.
- n. Check against limits: CHECK that the largest of the three results from steps k, l, and m is between -30 ps and + 30 ps.
- o. Enter the time on the test record.

Table 4-6: Delay between channels worksheet

Coupling	First measurement	Second measurement	Add first and second measurements	Divide sum by 2
CH 1 to CH 2 skew				
CH 1 to CH 3 skew				
CH 1 to CH 4 skew				

3. *Disconnect the hookup:* Disconnect the cable from the generator output at the input connectors of the channels.

Check Channel Isolation (Crosstalk)

Equipment required	One leveled sine-wave generator (Item 12) Four TCA-BNC adapters (Item 20) Three 50 Ω termination (Item 3) One 50 Ω , precision coaxial cable (Item 4)
Prerequisites	See page 4-1

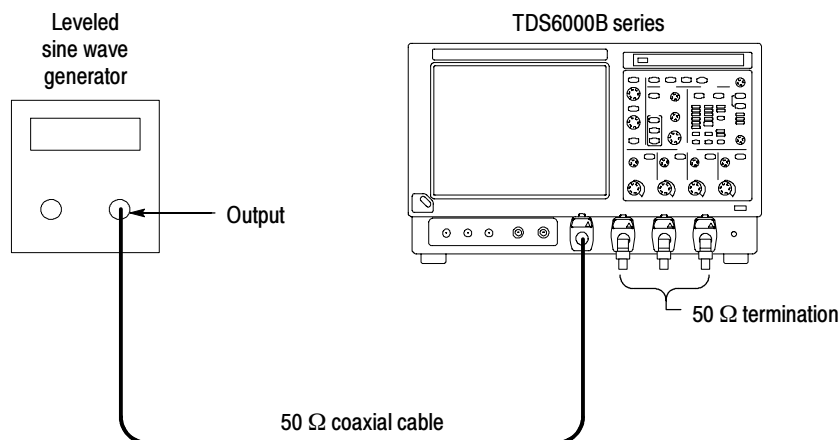

Figure 4- 11: Initial test hookup

1. Install the test hookup and preset the instrument controls:

a. Initialize the oscilloscope: Press the **DEFAULT SETUP** button.

b. Modify the initialized control settings:

- Turn on all vertical channels (press the **VERT** button of any off channels: CH 1, CH 2, CH 3, and CH 4).
- Set the Horizontal SCALE to **1.25 ns**.
- Set the Vertical SCALE of CH 1, CH 2, CH 3, and CH 4 to **200 mV**.
- From the toolbar, touch **Horiz** and select the **Acquisition** tab.
- Touch **Average** and set the number of averages to **16**.
- From the toolbar, touch **MEAS**.
- Touch the Source Channel **1** button.
- Select the **Ampl** tab; then touch the **Amplitude** button.
- Touch **Close**.
- Set the Trigger SOURCE to **CH 1**.
- Press **PUSH TO SET 50%**.

c. Hook up the test-signal source:

- Connect, through a 50 Ω precision coaxial cable, and a appropriate TCA adapter (preferable a SMA), the output of the generator to **CH 1** (see Figure 4-11).

- Connect TCA-adapters to the CH 2, CH 3, and CH 4 inputs.
 - Connect 50 Ω termination to the adapters on the CH 2, CH 3, and CH 4 inputs.
2. *Display the test signal:* If your instrument bandwidth is ≤ 1.5 GHz, skip to step 4.
- Set the generator to output a 1.5 GHz sine wave. Set the test signal amplitude for about five divisions on screen. Now fine adjust the generator output until the **CH 1 Amplitude** readout indicates the amplitude is 1.0 V. Readout may fluctuate around 1.0 V.
 - Set the Vertical SCALE for all channels to **100 mV**.
3. Confirm the input channels are within limits for channel isolation:
- a. Check — Amplitude of each trace other than CH 1 is 0.125 division or less (discount trace width). Enter the largest amplitude on the test record.
 - b. Move the signal to the **CH 2** input connector, change the Trigger SOURCE to **CH 2**, and move the 50 Ω termination to the CH 1 input.
 - c. Check — Amplitude of each trace other than CH 2 is 0.125 division or less (discount trace width). Enter the largest amplitude on the test record.
 - d. Move the signal to the **CH 3** input connector, change the Trigger SOURCE to **CH 3**, and move the 50 Ω termination to the CH 2 input.
 - e. Check — Amplitude of each trace other than CH 3 is 0.125 division or less (discount trace width). Enter the largest amplitude on the test record.
 - f. Move the signal to the **CH 4** input connector, change the Trigger SOURCE to **CH 4**, and move the 50 Ω termination to the CH 3 input.
 - g. Check — Amplitude of each trace other than CH 4 is 0.125 division or less (discount trace width). Enter the largest amplitude on the test record.
 - h. Select an unchecked vertical SCALE:
 - Move the signal to the CH1 input, change the Trigger Source to **CH 1**, and move the 50 Ω termination to the CH 4 input.
 - Press **PUSH TO SET 50%**.
 - Set the Vertical SCALE of CH 1, CH 2, CH 3, and CH 4 to **100 mV**.
 - Set the test signal amplitude for about five divisions on screen. Now fine adjust the generator output until the **CH 1 Amplitude** readout indicates the amplitude is 500 mV. Readout may fluctuate around 500 mV.

- Set the Vertical SCALE for all channels to **50 mV**.
- Repeat steps a through g.
- Move the signal to the CH 1 input, change the Trigger Source to **CH 1**, and move the 50 Ω termination to the CH 4 input.
- Press **PUSH TO SET 50%**.
- Set the Vertical SCALE of CH 1, CH 2, CH 3, and CH 4 to **20 mV**.
- Set the test signal amplitude for about five divisions on screen. Now fine adjust the generator output until the **CH 1 Amplitude** readout indicates the amplitude is 100 mV. Readout may fluctuate around 100 mV.
- Set the Vertical SCALE for all channels to **10 mV**.
- Repeat steps a through g.

4. *Display the test signal:*

- Move the signal to the CH 1 input, change the Trigger Source to **CH 1**, and move the 50 Ω termination to the CH 4 input.
- Press **PUSH TO SET 50%**.
- Set the Vertical SCALE of CH 1, CH 2, CH 3, and CH 4 to **200 mV**.

- Set the Horizontal SCALE to 2 to 5 cycles of the signal.
 - Set the generator frequency to **8 GHz** (TDS6804B) or **6 GHz** (TDS6604B) of your instrument. Set the test signal amplitude for about five divisions on screen. Now fine adjust the generator output until the **CH 1 Amplitude** readout indicates the amplitude is 1.0 V. Readout may fluctuate around 1.0 V.
 - Set the Vertical SCALE for all channels to **100 mV**.
5. Confirm the input channels are within limits for channel isolation:
- a. Check — Amplitude of each trace other than CH 1 is 0.5 division or less (discount trace width). Enter the largest amplitude on the test record.
 - b. Move the signal to the CH 2 input connector, change the Trigger SOURCE to CH 2, and move the 50 Ω termination to the CH 1 input.
 - c. Check — Amplitude of each trace other than CH 2 is 0.5 division or less (discount trace width). Enter the largest amplitude on the test record.
 - d. Move the signal to the CH 3 input connector, change the Trigger SOURCE to CH 3, and move the 50 Ω termination to the CH 2 input.
 - e. Check — Amplitude of each trace other than CH 3 is 0.5 division or less (discount trace width). Enter the largest amplitude on the test record.
 - f. Move the signal to the CH 4 input connector, change the Trigger SOURCE to CH 4, and move the 50 Ω termination to the CH 3 input.
 - g. Check — Amplitude of each trace other than CH 4 is 0.5 division or less (discount trace width). Enter the largest amplitude on the test record.
 - h. Select an unchecked Vertical SCALE:
 - Move the signal to CH 1, set the Trigger SOURCE to CH 1, and move the 50 Ω termination to the CH 4 input.
 - Press **PUSH TO SET 50%**.
 - Set the Vertical SCALE of CH 1, CH 2, CH 3, and CH 4 to **100 mV**
 - Set the test signal amplitude for about five divisions on screen. Now fine adjust the generator output until the **CH 1 Amplitude** readout indicates the amplitude is 500 mV. Readout may fluctuate around 500 mV.
 - Set the Vertical SCALE for all channels to **50 mV**.
 - Repeat steps a through g.

- Move the coaxial cable to CH 1, set the Trigger SOURCE to CH 1, and move the 50 Ω termination to the CH 4 input.
 - Set the Vertical SCALE of CH 1, CH 2, CH 3, and CH 4 to **20 mV**.
 - Set the test signal amplitude for about five divisions on screen. Now fine adjust the generator output until the **CH 1 Amplitude** readout indicates the amplitude is 100 mV. Readout may fluctuate around 100 mV.
 - Set the Vertical SCALE for all channels to **10 mV**.
 - Repeat steps a through g.
6. *Disconnect the hookup:* Disconnect the cable, termination, and adapters from the generator output and the input connector of the channel.

Check Input Impedance

Equipment required	One Digital Multimeter (Item 28) One Dual-Banana Connector, (Item 5) One precision 50 Ω coaxial cable (Item 4) One SMA male-to-female BNC adapter (Item 20)
Prerequisites	See page 4-1

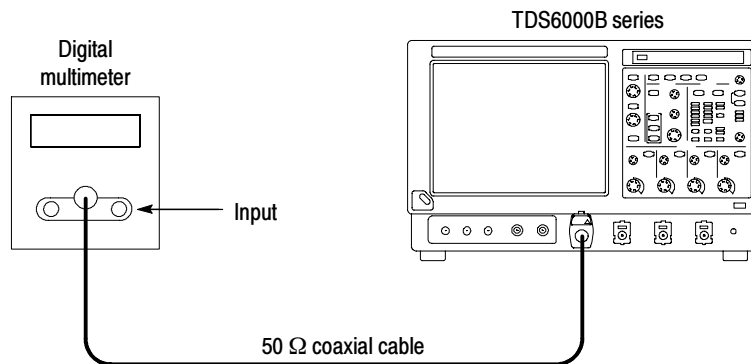

Figure 4- 12: Initial test hookup

1. *Install the test hookup and preset the instrument controls:*
 - a. *Hook up the test-signal source:* Connect, through a 50 Ω precision coaxial cable, the output of the multimeter to **CH 1** through adapters (see Figure 4-12).
 - b. Set the Vertical SCALE to 10 mV per division.
2. *Check input impedance against limits:*
 - a. *Measure the impedance:* Read and record the measured impedance.
 - b. Remove the dual banana connector from the digital multimeter (DMM), turn it 180 degrees and reinsert it in the DMM input.
 - c. *Measure the impedance:* Read and record the measured impedance.
 - d. Add the two measurements and divide the result by 2.
 - e. Check — Average of the two measurements is ≥ 48.75 Ohms and ≤ 51.25 Ohms. Enter average on the test record.
3. Set the Vertical SCALE to 100 mV per division and repeat step 2.
4. *Repeat steps 2 through 3 for the remaining input channels:*
 - a. Move the test setup to an unchecked input channel.
 - b. Set the Vertical SCALE of the channel to 10 mV per division.
 - c. Repeat steps 2 through 3.
5. *Disconnect the hookup:* Disconnect the equipment from the instrument.

Time Base System Checks

These procedures check those characteristics that relate to the time base system and are listed as checked under *Warranted Characteristics* in *Specifications*.

Check Long-Term Sample Rate and Delay Time Accuracy and Reference

Equipment required	One timer-counter (Item 11) One 50 Ω , precision coaxial cable (Item 4) One SMA male-to-female BNC adapter (Item 20) One sine wave generator (Item 12)
Prerequisites	See page 4-1

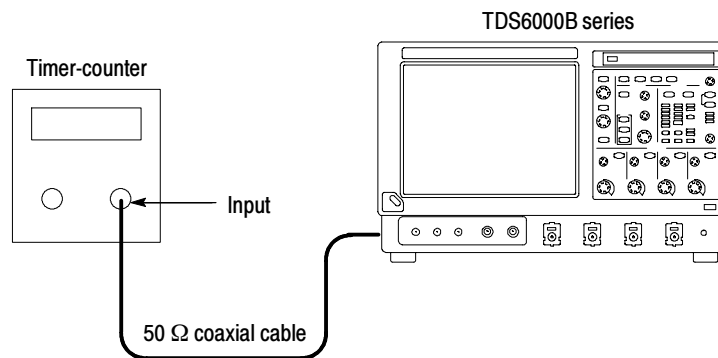

Figure 4-13: Initial test hookup

1. *Install the test hookup and preset the instrument controls:*
 - a. *Hook up the test-signal source:* Connect, through a 50 Ω precision coaxial cable, the input of the timer-counter to **REF OUT** (see Figure 4-13).
 - Set the timer-counter gate to 1 s.
 - Set the timer-counter to count the reference output.
 - b. *Initialize the oscilloscope:* Press the **DEFAULT SETUP** button.
2. *Confirm the time base is within limits for accuracies:*
 - a. *Check long-term sample rate and delay time accuracies against limits:*
 - CHECK that the count on the timer-counter is within limits.
 - Enter the count on the test record.

3. *Confirm reference is within limits for logic levels:*
 - a. *Display the test signal:*
 - Move the cable from the timer-counter to the CH 1 input through an adapter.
 - Set the Vertical **SCALE** to 1 V.
 - Use the Vertical **POSITION** knob to center the display on screen.
 - b. *Measure logic levels:*
 - From the toolbar, touch **MEAS** and select the **Ampl** tab.
 - Touch the **High** and **Low** buttons.
 - Touch the **Close** button.
 - c. *Check REF OUT output against limits:* CHECK that the **CH 1 High** readout is ≥ 1.0 volt and that the **CH 1 Low** readout ≤ 0.25 volts.
4. *Disconnect the hookup:* Disconnect the cable and adapter from the instrument.

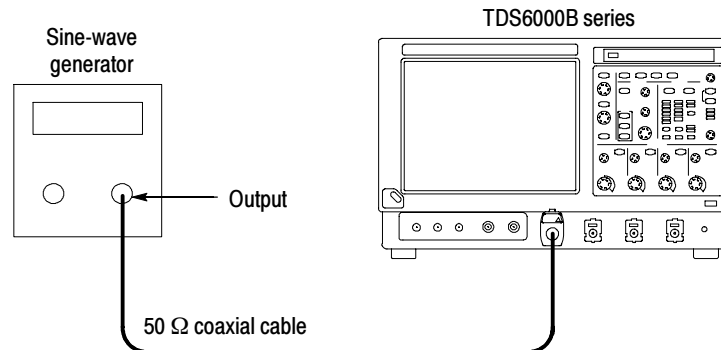

Figure 4-14: Initial test hookup

5. *Install the test hookup and preset the instrument controls:*
 - a. *Initialize the oscilloscope:* Press the **DEFAULT SETUP** button.
 - b. *Hook up the test-signal source:* Connect, through a 50 Ω precision coaxial cable, the output of the sine wave generator to **CH 1** input through an adapter (see Figure 4-14).
 - From the toolbar, touch **MEAS** and select the **Ampl** tab.
 - Touch the **Pk-Pk** button.

- Touch the **Close** button.
 - Set the Vertical **SCALE** to 50 mV.
 - Set the generator for a 10.0 MHz sine wave.
 - Set the generator to output a 4 division signal. Adjust the output until the Pk-Pk readout displays 200 mV.
- c. *Set the oscilloscope controls:*
- Move the cable from the **CH 1** input to the rear-panel **Ext Ref** input (see Figure 4-15).
 - Touch **Menu** to select menu mode.
 - Touch **Utilities** and select **External Signals**.
 - Touch the **Internal** button to select the external reference (the button name changes to External).

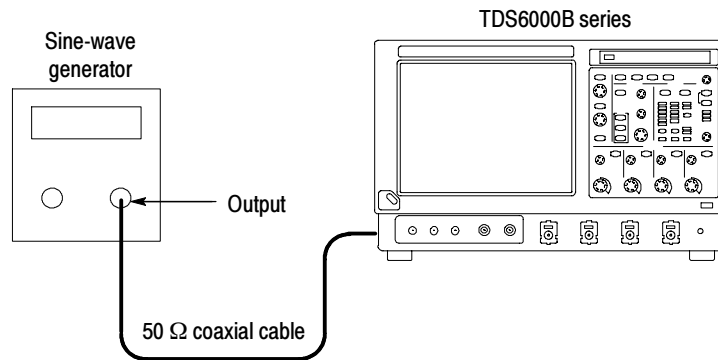

Figure 4- 15: Final test hookup

6. *Confirm external reference:*
- a. *Perform a signal path compensation:*
 - Touch **Utilities** and select **Instrument Calibration**.
 - Touch **Calibrate** and wait for the signal path compensation to finish.
 - b. *Check the completion status:* If the Status is Fail, refer the instrument to qualified service personnel.
7. *Disconnect the hookup:*
- a. Disconnect all test equipment from the instrument.

- b. *Set the oscilloscope controls:*
 - Touch **Utilities** and select **External Signals**.
 - Touch the **External** button to select the internal reference (the button name changes to Internal).
- c. *Perform a signal path compensation:*
 - Touch **Utilities** and select **Instrument Calibration**.
 - Touch **Calibrate** and wait for the signal path compensation to finish.

Check Delta Time Measurement Accuracy

Equipment required	One 50 Ω , precision coaxial cable (Item 4) One Connector, BNC "T", male BNC-to-dual female BNC (Item 6) One Pulse Generator, Wavetek 9500 or equivalent (Item 21) One SMA female to BNC male connector (Item 24) One BNC elbow connector (Item 25) One SMA "T", male to two SMA female connectors (Item 23) Two SMA termination connectors, short circuit, (Item 26) One SMA male-to-female BNC adapter (Item 20) One 2X attenuator, 50 Ω , female BNC-to-male BNC (Item 27)
Prerequisites	See page 4-1

This procedure checks the "sample rate" portion of the Delta Time Measurement Accuracy as listed in *Specifications*. The previous procedure, *Check Long-Term Sample Rate and Delay Time Accuracy and Reference*, see page 4-40, verified the "PPM" portion of the delta time specification.

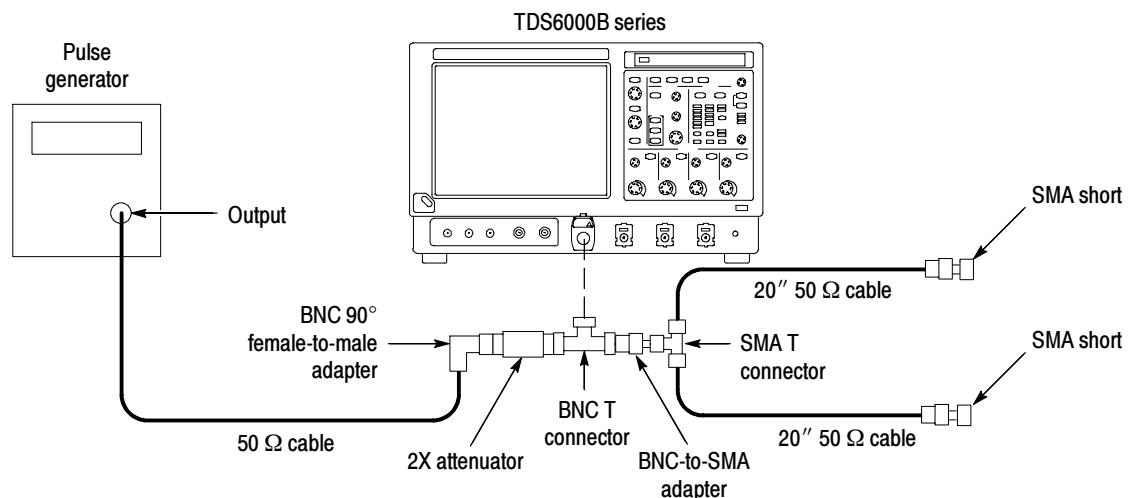

Figure 4-16: Delta time accuracy test hookup

1. *Install the test hookup and preset the instrument controls:*
 - a. *Initialize the oscilloscope:* Press the **DEFAULT SETUP** button.
 - b. *Hook up the pulse generator (see Figure 4-16 on page 4-44):*
 - Connect the pulse generator output to a **50 Ω** precision coaxial cable followed by a 90° right-angle female to male BNC adapter, then a

50 Ω 2X attenuator. The attenuator is connected to one side of the female BNC T connector. The other side of the BNC T is connected to BNC male to SMA adapter. The SMA side is connected to the male side of the SMA T connector. (Keep the distance between the BNC T and SMA T as short as possible). Connect 20 inch **50 Ω** coaxial cables to each female side of the SMA T connector. Connect a female to female SMA adapter to both male coaxial connectors. Connect the SMA short, to the remaining female SMA adapter. Now connect the male BNC T connector to **CH 1**.

- Set the pulse generator output for a positive-going pulse with a rise-time as shown in Table 4-7 on page 4-46 for your instrument, and for the fastest possible rep rate (at least 1 kHz).
 - Set the pulse generator output for about 500 mV. (This amplitude can be adjusted later to get a 5-division pulse on screen.)
- c. *Modify the initialized front-panel control settings:*
- Press **AUTOSET**. You may see both positive and negative pulses. Adjust the Trigger **LEVEL** knob so the trigger level is about 50% of the rising edge of the positive pulse.
 - From the toolbar, touch the **Horiz** button and select the Acquisition tab. Press the **RT** button to turn on the Real Time Only.
 - Set the horizontal **SCALE** to 5 ns/division. The pulse width should be about **6 ns**. The indicated sample rate should be 20 GS/s.
 - Adjust pulse amplitude and instrument vertical scale and position as necessary to obtain about **5 divisions** of the **positive** pulse.
- d. *Set up for statistics measurements:*
- Readjust the Trigger **LEVEL** knob so the trigger level is about 50% of the rising edge of the positive pulse.
 - Press **RUN/STOP** button to freeze the display.
 - Touch **MEAS** and select the **Time** tab to bring up the Time Measurements menu.
 - Touch the **Positive Width** button.
 - Touch Setup **Statistics**. Touch the Measurement Statistics **All** button and then touch **Reset** to reset the statistics.
 - Touch **Weight n=**. On the keypad press **1000**, then **ENTER**. Touch **Setup**.
 - Touch Setup **Ref Levs** and then touch **Absolute**.

- Touch **MidRef**. Using the keypad or multipurpose knobs, set the mid reference to **150 mV**. Touch **Close**.
- Press the **RUN/STOP** button to start the acquisitions.
- Wait about 30 seconds.
- Press **RUN/STOP** button to freeze the display.
- Record the all statistics values.
- Calculate the difference of the Maximum (M) minus the mean (μ) of the statistics values.
- Calculate the difference of the mean (μ) minus the Minimum (m) of the statistics values.
- Both differences must be less than or equal to the Delta-time accuracy limit shown in Table 4-7 for your instrument.
- Enter the result for delta time on the test record.

Table 4-7: Delta time measurement

Instrument type	Pulse rise time range	Delta time accuracy limit
TDS6604B	140 ps - 400 ps	≤ 0.030 ns
TDS6804B	140 ps - 400 ps	≤ 0.030 ns

e. *Repeat for all other channels:*

- Note the vertical scale setting of the channel just confirmed.
- Press the Vertical channel button for the channel just confirmed to remove the channel from display.
- Touch **MEAS** and the **Clear** to remove the measurement.
- Press the front-panel button that corresponds to the channel you are to confirm.
- Set vertical SCALE to the setting noted in step e, first bullet.
- Press the Trigger Source button to toggle the source to the channel selected.
- Move the test hookup to the channel you selected.
- Press **RUN/STOP** button to start the display.
- Repeat step d.

2. *Disconnect all test equipment from the instrument.*

Trigger System Checks

These procedures check those characteristics that relate to the trigger system and are listed as checked in *Specifications*.

Check Time Accuracy for Pulse, Glitch, Timeout, and Width Triggering

Equipment required	One sine wave generator (Item 12) One 10X attenuator (Item 1) One 50 Ω , precision coaxial cable (Item 4) One SMA male-to-female BNC adapter (Item 20)
Prerequisites	See page 4-1

1. *Install the test hookup and preset the instrument controls:*
 - a. *Initialize the instrument:* Press the **DEFAULT SETUP** button.
 - b. *Modify the default setup:* Set the horizontal **SCALE** to 10 ns.
 - c. *Hook up the test-signal source:* Connect the output of the sine wave generator (Item 12) to CH 1.

Do this through a 50 Ω precision coaxial cable, followed by a 10X attenuator and adapter. See Figure 4-17.

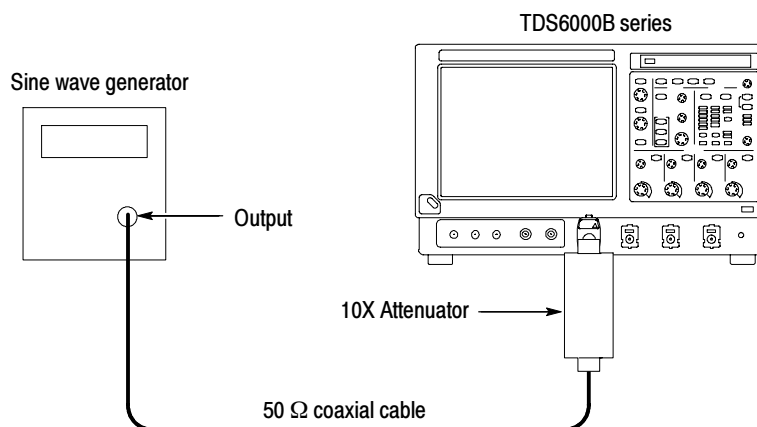

Figure 4-17: Initial test hookup

2. *Confirm that the trigger system is within time-accuracy limits for pulse-glitch or pulse-width triggering (time range ≤ 500 ns):*
 - a. *Display the test signal:* Set the output of the sine wave generator for a 100 MHz, five-division sine wave on screen. Press **PUSH TO SET 50%**.
 - b. *Set the trigger mode:* Press the Trigger **MODE** button to toggle it to **NORMAL**.
 - c. *Set upper and lower limits that ensure triggering:* See Figure 4-18.
 - Press the front-panel **ADVANCED** button and select the **A Event** tab; then click the Trigger Type menu and select **Width**.
 - Touch the Pulse Width menu and select **Inside** limits.
 - Touch **Upper Limit** and use the keyboard to set the upper limit to 10 ns: press **10**, then **n**, and **ENTER**.
 - Touch **Lower Limit** and use the keypad to set the lower limit to 2 ns.
 - d. *Change limits until triggering stops:*
 - Press **PUSH TO SET 50%**.
 - While doing the following subparts, monitor the display (it will stop acquiring) and the front-panel light **TRIG'D** (it will extinguish) to determine when triggering is lost.
 - Use the multipurpose knob to *increase* the **Lower Limit** readout until triggering is lost.
 - CHECK that the **Lower Limit** readout, after the oscilloscope loses triggering, is within 3.5 ns to 6.5 ns, inclusive.
 - Enter the time on the test record.
 - Use the keypad to return the **Lower Limit** to 2 ns and reestablish triggering.
 - Touch **Upper Limit**; then use the multipurpose knob to slowly *decrease* the **Upper Limit** readout until triggering is lost.
 - CHECK that the **Upper Limit** readout, after the oscilloscope loses triggering, is within 3.5 ns to 6.5 ns, inclusive.
 - Enter the time on the test record.

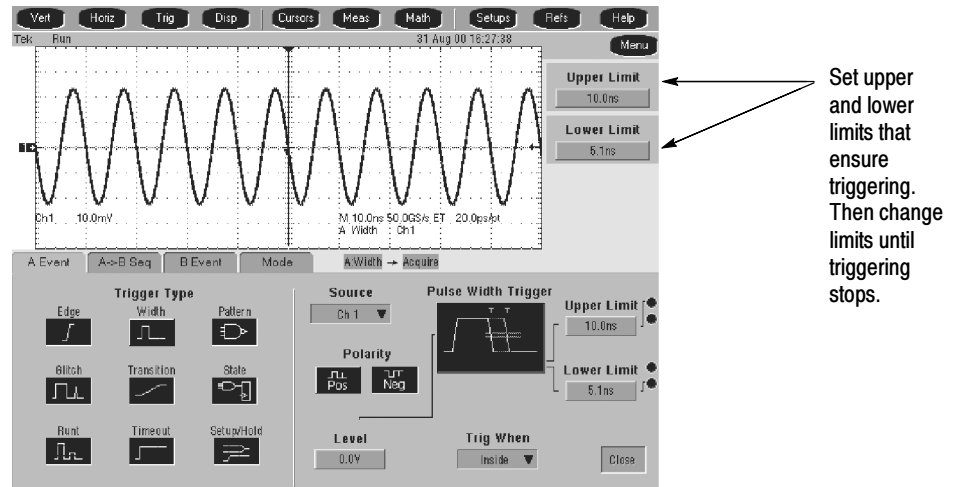

Figure 4-18: Measurement of time accuracy for pulse and glitch triggering

3. Confirm the trigger system is within time-accuracy limits for pulse-glitch or pulse-width triggering (time range >520 ns):
 - a. Set upper and lower limits that ensure triggering at 250 kHz:
 - Touch **Upper Limit**. Use the keyboard to set the upper limit to 4 μ s.
 - Touch **Lower Limit**. Use the keypad to set the lower limit to 500 ns.
 - b. Display the test signal:
 - Set the Horizontal **SCALE** to 4 μ s.
 - Set the output of the sine wave generator for a 250 kHz, five-division sine wave on screen. Set the Vertical **SCALE** to 20 mV (the waveform will overdrive the display).
 - Press **PUSH TO SET LEVEL 50%**.
 - c. Check against limits: Do the following subparts in the order listed.
 - Use the multipurpose knob to *increase* the **Lower Limit** readout until triggering is lost.
 - CHECK that the **Lower Limit** readout, after the oscilloscope stops triggering, is within 1.9 μ s to 2.1 μ s, inclusive.
 - Enter the time on the test record.
 - Use the keypad to return the **Lower Limit** to 500 ns and reestablish triggering.

- Touch **Upper Limit**; then use the multipurpose knob to slowly *decrease* the **Upper Limit** readout until triggering stops.
 - CHECK that the **Upper Limit** readout, after the oscilloscope loses triggering, is within 1.9 μ s to 2.1 μ s, inclusive.
 - Enter the time on the test record.
4. *Disconnect the hookup*: Disconnect the cable and adapter from the generator output and the input connector of **CH 1**.

Check Sensitivity, Edge Trigger, DC Coupled

Equipment required	One sine wave generator (Item 12) Two precision 50 Ω coaxial cables (Item 4) One 10X attenuator (Item 1) One BNC T connector (Item 6) One SMA male-to-female BNC adapter (Item 20) One 5X attenuator (Item 2)
Prerequisites	See page 4-1.

1. *Install the test hookup and preset the instrument controls*:
- a. *Initialize the oscilloscope*: Press the **DEFAULT SETUP** button.
 - b. *Modify the initialized front-panel control settings*:
 - Set the Horizontal **SCALE** to 20 ns.
 - Press the Trigger **MODE** button to toggle it to **Normal**.
 - From the toolbar, touch **Horiz** and select the **Acquisition** tab.
 - Touch **Average** and set the number of averages to **16**.
 - c. *Hook up the test-signal source*:
 - Connect the signal output of the generator to a BNC T connector. Connect one output of the T connector to **CH 1** through a 50 Ω precision coaxial cable and an adapter. Connect the other output of the T connector to the **AUX INPUT**. See Figure 4-19.

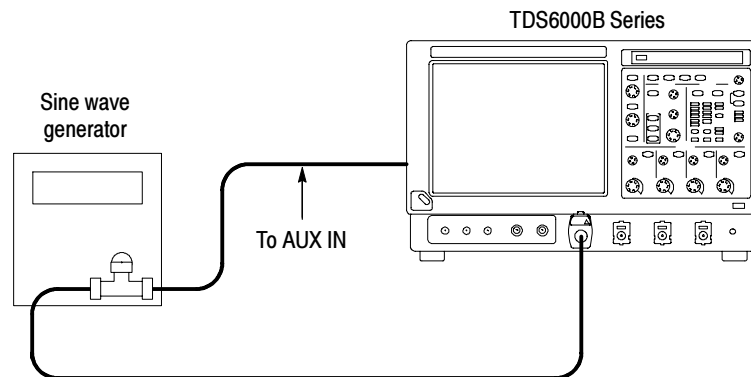

Figure 4-19: Initial test hookup

2. *Confirm the trigger system is within sensitivity limits (50 MHz):*
 - a. *Display the test signal:*
 - Set the generator frequency to 50 MHz.
 - From the toolbar, touch **MEAS**.
 - Touch Setup **Ref Levs**; then touch the **Min-Max** button.
 - Touch the **Setup** button and select the **Ampl** tab; then touch the **Amplitude** button.
 - Touch **Close**.
 - Press **PUSH TO SET 50%**.
 - Set the test signal amplitude for about three and a half divisions on screen. Now fine adjust the generator output until the **CH 1 Amplitude** readout indicates the amplitude is 350 mV. Readout may fluctuate around 350 mV.
 - Disconnect the 50 Ω precision coaxial cable at **CH 1** and reconnect it to **CH 1** through a 10X attenuator.
 - b. *Check the Main trigger system for stable triggering at limits:*
 - Read the following definition: A stable trigger is one that is consistent; that is, one that results in a uniform, regular display triggered on the selected slope (positive or negative). This display should *not* have its trigger point switching between opposite slopes, nor should it roll across the screen. At horizontal scale settings of 2 ms/division and faster, **TRIG'D** will remain constantly lighted. It will flash for slower settings.

- Press the Trigger **Slope** button to select the positive slope.
- Adjust the Trigger **LEVEL** knob so that there is a stable trigger. **CHECK** that the trigger is stable for the test waveform on the positive slope.
- Press the Trigger **Slope** button to select the negative slope. Adjust the Trigger **LEVEL** knob so that there is a stable trigger.
- **CHECK** that the trigger is stable for the test waveform on the negative slope.
- Leave the trigger system triggered on the positive slope of the waveform before continuing to the next step.

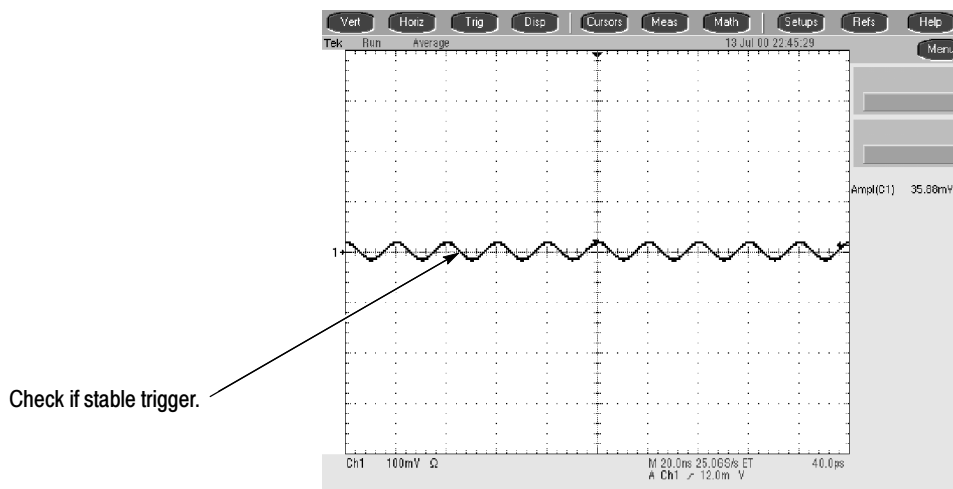

Figure 4-20: Measurement of trigger sensitivity - 50 MHz results shown

- c. *Check Delayed trigger system for stable triggering at limits:* Do the following subparts in the order listed.
 - From the toolbar touch **Trig**, select the **A Event** tab, and set the **Source** to CH 1.
 - Select the **A->B Seq** tab, and touch the A then B **Trig After Time** button.
 - Select the **B Event** tab, and touch the **Set 50%** button.

- CHECK that a stable trigger is obtained for the test waveform for both the positive and negative slopes of the waveform. Use the **TRIGGER LEVEL** knob to stabilize the Main trigger. Touch B Trig Level and use the keypad or the multipurpose knob/FINE button to stabilize the Delayed trigger. Touch one of the Slope buttons to switch between trigger slopes. See Figure 4-20 on page 4-52.
 - Leave the Delayed trigger system triggered on the positive slope of the waveform before continuing to the next step. Also, return to the main trigger: select the A->B Seq tab and touch the A->B Sequence **A Only** button. Then select the A Event tab.
 - Touch **Close**.
3. *Confirm the AUX Trigger input:*
- a. *Display the test signal:*
- Remove the 10X attenuator and reconnect the cable to **CH 1**.
 - Set the signal amplitude as follows:

TDS6604B	2.5 divisions
TDS6804B	2.5 divisions
 - Now fine adjust the generator output until the **CH 1 Amplitude** readout indicates the amplitude is as follows (Readout may fluctuate):

TDS6604B	250 mV
TDS6804B	250 mV
- b. *Check the AUX trigger source for stable triggering at limits:* Do the following in the order listed.
- Use the definition for stable trigger from step 2b.
 - Press the Trigger **SOURCE** button to toggle it to **EXT**.
 - Press **PUSH TO SET 50%**.
 - CHECK that a stable trigger is obtained for the test waveform on both the positive and negative slopes. Press the Trigger **SLOPE** button to switch between trigger slopes. Use the Trigger **LEVEL** knob to stabilize the trigger if required.
 - Leave the trigger system triggered on the positive slope of the waveform before proceeding to the next check.
 - Press the Trigger **SOURCE** button to toggle it to **CH 1**.

4. *Confirm that the trigger system is within sensitivity limits (full bandwidth):*

a. *Set the Horizontal Scale:* Set the Horizontal **SCALE** to 200 ps.

b. *Display the test signal:*

- Set the generator frequency to full bandwidth as follows:

TDS6604B **3 GHz**

TDS6804B **3 GHz**

- Set the test signal amplitude for about seven divisions on screen. Now fine adjust the generator output until the **CH 1 Amplitude** readout indicates the amplitude is 750 mV. (Readout may fluctuate around 750 mV).

- Disconnect the cable at **CH 1** and reconnect it to **CH 1** through a 5X attenuator. Check that a stable trigger is obtained.

c. Repeat step 2, substep b for the full bandwidth selected.

d. *Display the test signal:*

- Set the generator frequency to full bandwidth as follows:

TDS6604B **1.5 GHz**

TDS6804B **1.5 GHz**

- Disconnect the 5X attenuator. Set the test signal amplitude for about five divisions on screen. Now fine adjust the generator output until the **CH 1 Amplitude** readout indicates the amplitude is 500 mV. (Readout may fluctuate around 500 mV).

- Disconnect the cable at **CH 1** and reconnect it to **CH 1** through a 5X attenuator. Check that a stable trigger is obtained.

e. Repeat step 2, substep c only, for the full bandwidth selected.

f. *Display the test signal:*

- Set the generator frequency to 2 GHz.

- Set the Horizontal **SCALE** to 1.25 ns.

- Remove the 5X attenuator and reconnect the cable to **CH 1**.

- Set the generator amplitude on screen as follows:

TDS6604B	4 divisions
TDS6804B	4 divisions
- Now fine adjust the generator output until the **CH 1 Amplitude** readout indicates the amplitude is as follows (Readout may fluctuate):

TDS6604B	350 mV
TDS6804B	350 mV
- g. Repeat step 3, substeps b only, for the full bandwidth selected.

NOTE. *You just checked the trigger sensitivity. If desired, you may repeat steps 1 through 4c for the other channels (CH 2, CH 3, and CH 4).*

5. *Disconnect the hookup:* Disconnect the cables and adapter from AUX IN and the channel last tested.

Output Signal Checks

The procedure that follows checks those characteristics of the output signals that are listed as checked under *Warranted Characteristics* in *Specifications*. The oscilloscope outputs these signals at its front panel.

Check Outputs — CH 3 Signal Out and Aux Trigger Out

Equipment required	Two precision 50 Ω coaxial cables (Item 4) One calibration generator (Item 10) Two SMA male-to-female BNC adapter (Item 20)
Prerequisites	See page 4-1. Also, the oscilloscope must have passed <i>Check DC Voltage Measurement Accuracy</i> on page 4-13.

1. *Install the test hookup and preset the instrument controls:*

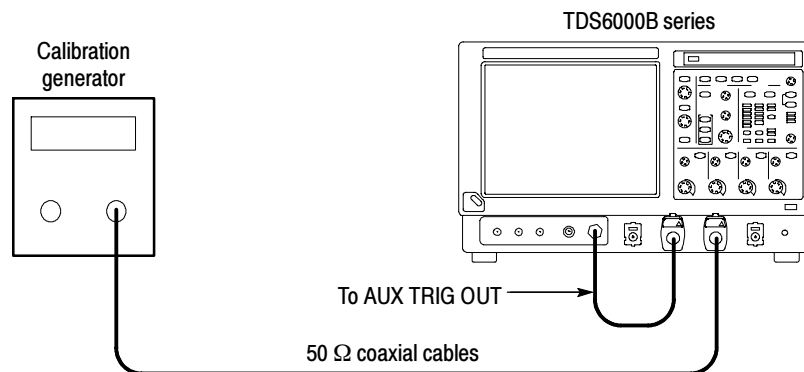

Figure 4-21: Initial test hookup

- Hook up test-signal source 1 (See Figure 4-21):*
 - Connect the standard amplitude output of a calibration generator through a 50 Ω precision coaxial cable to **CH 3** through an adapter.
 - Set the calibration generator to output a 0.500 V square wave.
- Hook up test-signal source 2:* Connect the **Aux Out** to **CH 2** through a 50 Ω precision cable and an adapter.
- Initialize the oscilloscope:* Press the **DEFAULT SETUP** button.
- Modify the initialized front-panel control settings:*
 - Press the Vertical **CH 1** button to toggle it off.
 - Press the Vertical **CH 3** button to display that channel.
 - Push Trigger **Source** to toggle the source to **CH 3**.
 - Set the Horizontal **SCALE** to 200 μ s.
 - If necessary, adjust the calibration generator output for 5 divisions of amplitude.

- From the toolbar, touch **Horiz** and select the **Acquisition** tab.
 - Touch **Average** and set the number of averages to **64**.
 - Touch the **Close** button.
2. *Confirm AUX OUT is within limits for logic levels:*
- a. *Display the test signal:*
 - Press the Vertical **CH 3** button to turn off CH 3.
 - Press the Vertical **CH 2** button to display that channel.
 - Set the Vertical **SCALE** to 500 mV.
 - Use the Vertical **POSITION** knob to center the display on screen.
 - b. *Measure logic levels:*
 - From the toolbar, touch **MEAS** and select the **Ampl** tab.
 - Touch the **High** and **Low** buttons.
 - Touch the **Close** button.
 - c. *Check AUX OUT output against limits:* CHECK that the **CH 2 High** readout is ≥ 1.0 volt and that the **CH 2 Low** readout ≤ 0.25 volts. See Figure 4-22.

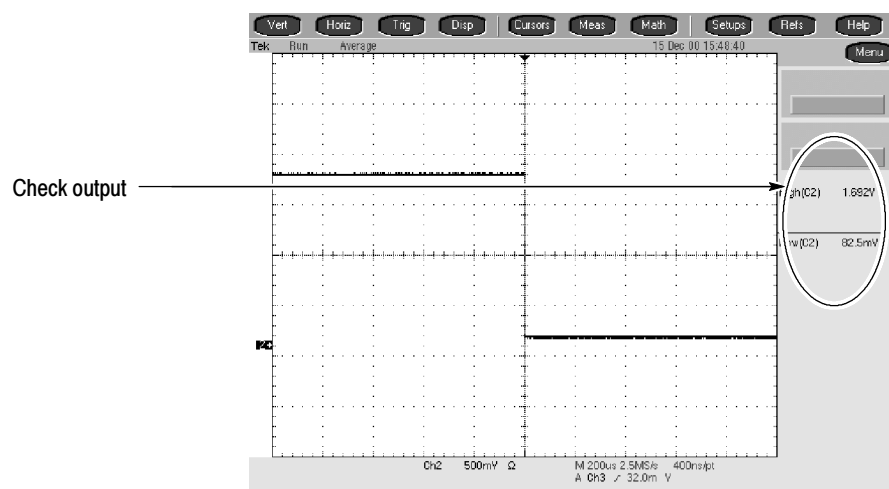

Figure 4-22: Measurement of trigger out limits

3. *Disconnect all test equipment from the instrument.*

Check Probe Compensation Output

Equipment required	<p>Two dual-banana connectors (Item 5)</p> <p>One BNC T connector (Item 6)</p> <p>Two precision 50 Ω coaxial cables (Item 4)</p> <p>One DC calibration generator (Item 9)</p> <p>One SMA-female-to-SMA female cable (Item 22)</p> <p>One SMA-to-BNC adapter (Item 20)</p>
Prerequisites	See page 4-1. Also, the oscilloscope must have passed <i>Check Long-Term Sample Rate and Delay Time Accuracy and Reference</i> on page 4-40.

1. Install the test hookup and preset the instrument controls:

a. Hook up test-signal:

- Connect one of the SMA cables to **CH 1** through an adapter. See Figure 4-23.
- Connect the other end of the cable just installed to the **PROBE COMPENSATION** output. See Figure 4-23.

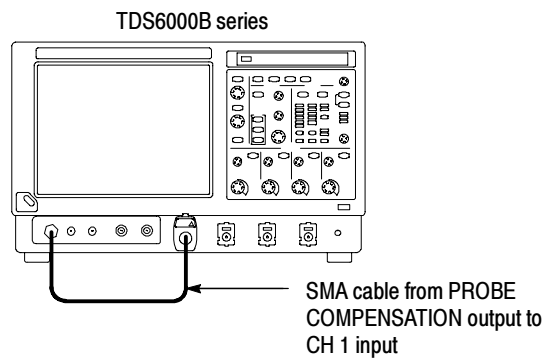

Figure 4-23: Initial test hookup

b. Initialize the oscilloscope: Press the **DEFAULT SETUP** button.

c. Modify the initialized front-panel control settings:

- Set the **Vertical SCALE** to 100 mV.
- Touch the **Vert** button and then touch **Offset**. Adjust the Ch1 Offset to **-0.15 V** using the multipurpose knob.
- Set the Horizontal **SCALE** to 200 μ s.

- Press **PUSH TO SET 50%**.
 - Use the Vertical **POSITION** knob to center the display on screen.
 - From the toolbar, touch **Horiz** and select the **Acquisition** tab.
 - Touch **Average** and set the number of averages to **128**.
2. Confirm that the Probe Compensator signal is within limits for frequency:
- a. Measure the frequency of the probe compensation signal:
 - From the toolbar, touch **MEAS** and select the **Time** tab.
 - Touch the **Freq** button.
 - b. Check against limits:
 - CHECK that the **CH 1 Freq** readout is within 950 Hz to 1.050 kHz, inclusive. See Figure 4-24.
 - Enter the frequency on the test record.
 - Touch **Clear** to remove the measurement.

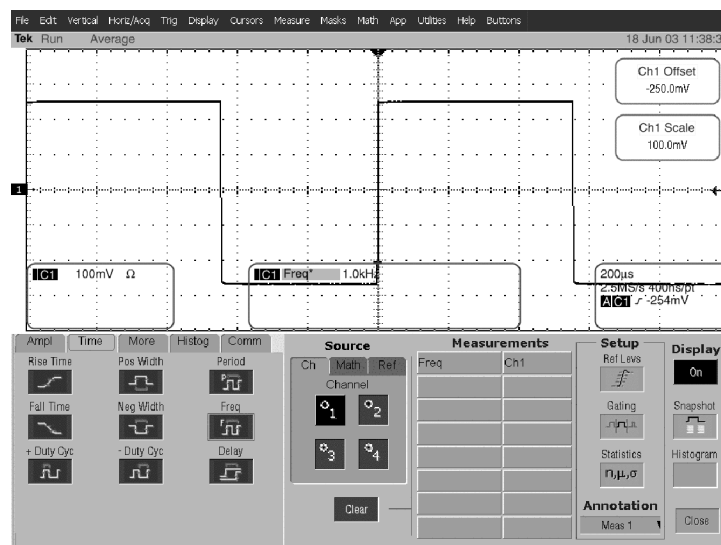

Figure 4-24: Measurement of probe compensator frequency

- c. Save the probe compensation signal in reference memory:
 - Touch **Refs**; then select the **Ref 1** tab.

- Touch the **Save Wfm to Ref1 Save** button to save the probe compensation signal in reference 1.
 - Disconnect the cable from **CH 1** and the probe compensation connector.
 - Touch the **Display** button to toggle it to on to displayed the stored signal.
- d. *Hook up the DC standard source:*
- Set the output of a DC calibration generator to off or 0 volts.
 - Connect the output of a DC calibration generator through a dual-banana connector followed by a 50 Ω precision coaxial cable to one side of a BNC T connector. See Figure 4-25.
 - Connect the Sense output of the generator through a second dual-banana connector followed by a 50 Ω precision coaxial cable to the other side of the BNC T connector. Now connect the BNC T connector to **CH 1** through a TCA-BNC or BNC-to-SMA adapter. See Figure 4-25.

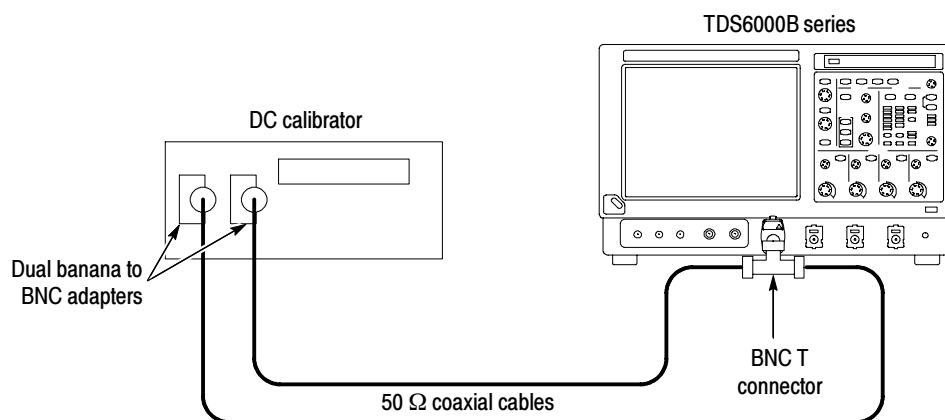

Figure 4- 25: Subsequent test hookup

- e. *Measure amplitude of the probe compensation signal:*
- From the toolbar, touch **Horiz** and select the **Acquisition** tab.
 - Touch **Average** and set the number of averages to **16** using the keypad or the multipurpose knob.
 - Adjust the output of the DC calibration generator until it precisely overlaps the top (upper) level of the stored probe compensation signal. (This value will be near 0 V).

- Record the setting of the DC generator.
 - Adjust the output of the DC calibration generator until it precisely overlaps the base (lower) level of the stored probe compensation signal. (This value will be near -370 mV).
 - Record the setting of the DC generator.
- f. Touch **Close** to remove the menus from the display. See Figure 4-26.

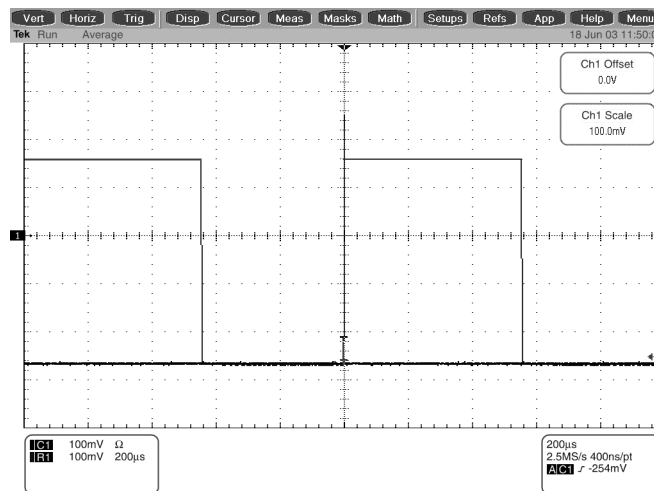

Figure 4-26: Measurement of probe compensator amplitude

- g. *Check against limits:*
- Subtract the value just obtained (base level) from that obtained previously (top level).
 - CHECK that the difference obtained is within 300 mV to 450 mV, inclusive.
 - Enter voltage difference on test record.
3. *Disconnect the hookup:* Disconnect the cable and adapter from **CH 1**.

Serial Trigger Checks (Option ST Only)

These procedures check those characteristics that relate to the serial trigger system and are listed as checked in *Specifications*.

Check Serial Trigger Baud Rate Limits and Word Recognizer Position Accuracy

Equipment required	One precision 50 Ω coaxial cables (Item 4) One sine-wave generator (Item 12) One TCA-BNC or TCA-SMA adapter (item 20)
Prerequisites	See page 4-1. Also, the oscilloscope must have passed <i>Check DC Voltage Measurement Accuracy</i> on page 4-13.

1. *Install the test hookup and preset the instrument controls:*

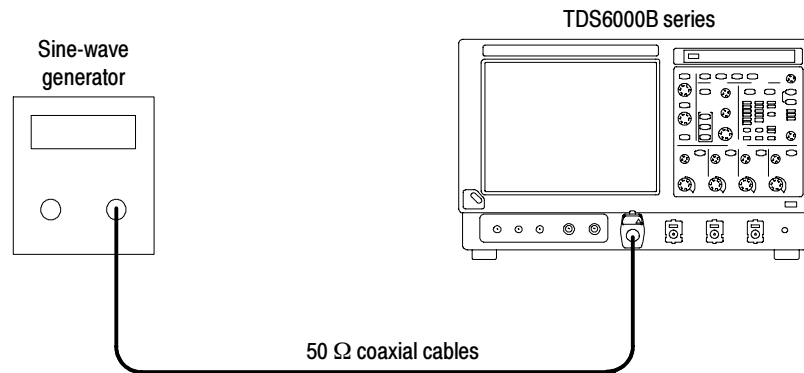

Figure 4-27: Initial test hookup

- Hook Up the test-signal source (see Figure 4-27):*
 - Connect the sine wave output of the sine-wave generator through a 50 Ω precision coaxial cable to CH 1 through an adapter.
 - Set the sine-wave generator to output a 433 MHz sine wave.
- Initialize the instrument:* Press the **DEFAULT SETUP** button.
- Modify the initialized front-panel control settings:
 - Set the vertical **SCALE** to 50 mV per division.
 - Set the horizontal **SCALE** to 2.5 ns per division.
 - Adjust the sine-wave generator output for 4 divisions of amplitude centered on the display.

- Adjust the trigger **LEVEL** to trigger at 25% (-1 division) on the sine wave.

Table 4-8: Serial pattern data

Serial pattern data	Trigger location
DB6D B6DB ₁₆	One UI before the 0
B6DB 6DB6 ₁₆	At the 0
6DB6 DB6D ₁₆	One UI after the 0

2. *Verify that the signal path can do isolated 0 and pattern matching circuits can do isolated 1:*
 - a. From the toolbar, touch **Cursors** and then the **Setup** button.
 - b. Set the Tracking Mode to **Tracking**.
 - c. Touch the **Close** button.
 - d. Adjust the cursors until the Δt readout equals 800 ps (one unit interval). Center the cursors around the center graticule line (see Figure 4-28).
 - e. From the toolbar, touch **Trig** and select the **A Event** tab, touch the **Select** button from the Trigger Type.
 - f. Touch the **Serial** button and then set the Standard to **GB Ethernet**.
 - g. Touch the **Editor** button.
 - h. Set the Format to **Hex** and then touch the **Clear** button.
 - i. Enter data into the Serial Pattern Data field for one of the settings in Table 4-8 that is not yet checked. (Start with the first setting listed.)
 - j. Touch **Apply**.
 - k. Verify that the instrument triggers one Unit Interval (UI, one baud divided by the bit period) before the 0 in the input signal (see Figure 4-28). Enter pass or fail in the test record.
 - l. Touch the **Clear** button.
 - m. Enter data into Serial Pattern Data field for the next setting in Table 4-8 that is not yet checked.
 - n. Touch **Apply**.
 - o. Verify that the instrument triggers at the 0 in the input signal (see Figure 4-28). Enter pass or fail in the test record.

Triggered 1 UI before a 0

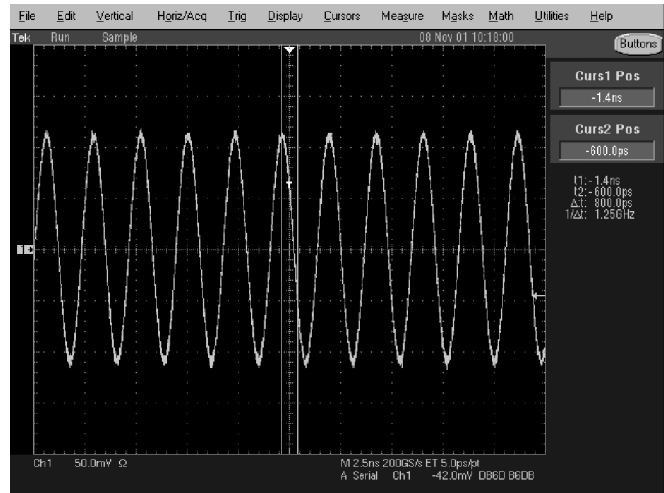

Triggered on a 0

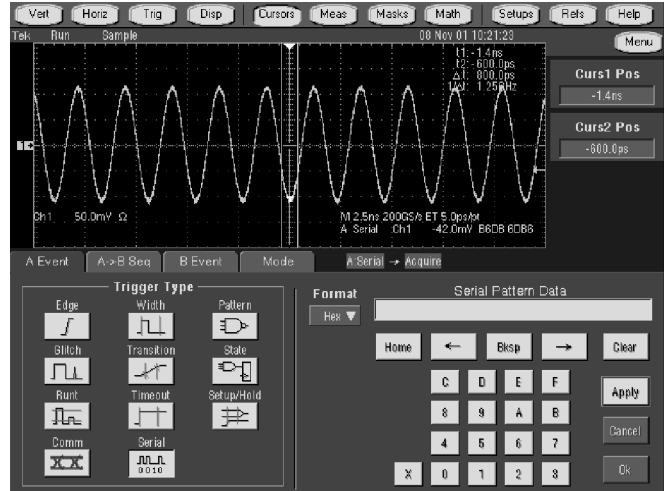

Triggered 1 UI after a 0

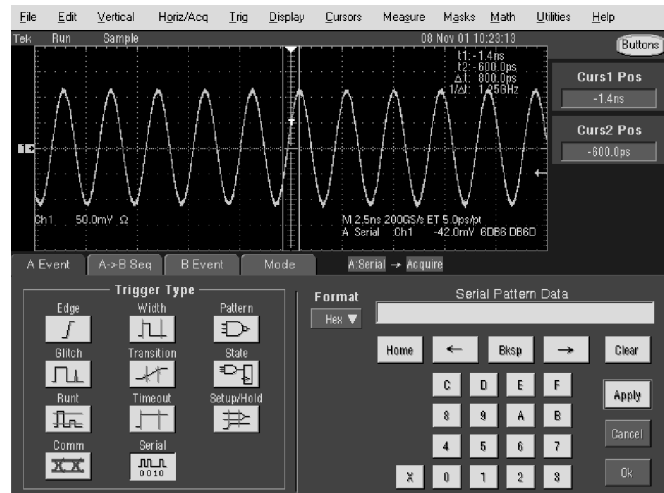

Figure 4-28: Isolated 0 triggering

- p. Touch the **Clear** button.
- q. Enter data into Serial Pattern Data field for the next setting in Table 4-8 that is not yet checked.
- r. Touch **Apply**.
- s. Verify that the instrument triggers one Unit Interval (UI) after the 0 in the input signal (see Figure 4-28). Enter pass or fail in the test record.

Table 4-9: Word recognizer data

Serial pattern data	Trigger location
2492 4924 ₁₆	One UI before the 1
4924 9249 ₁₆	At the 1
9249 2492 ₁₆	One UI after the 1

3. *Verify that the serial path and pattern matching circuits can do isolated 1s:*
 - a. Adjust the trigger **LEVEL** to trigger at 75% (+1 division) on the sine wave.
 - b. Touch the **Clear** button.
 - c. Enter data into the Serial Pattern Data field for one of the settings in Table 4-9 that is not yet checked. (Start with the first setting listed.)
 - d. Touch **Apply**.
 - e. Verify that the instrument triggers one Unit Interval (UI) before the 1 in the input signal (see Figure 4-29). Enter pass or fail in the test record.
 - f. Touch the **Clear** button.
 - g. Enter data into the Serial Pattern Data field for the next setting in Table 4-9 that is not yet checked.
 - h. Touch **Apply**.
 - i. Verify that the instrument triggers at the 1 in the input signal (see Figure 4-29). Enter pass or fail in the test record.
 - j. Touch the **Clear** button.
 - k. Enter data into the Serial Pattern Data field for the next setting in Table 4-9 that is not yet checked.
 - l. Touch **Apply**.

Triggered 1 UI before a 1

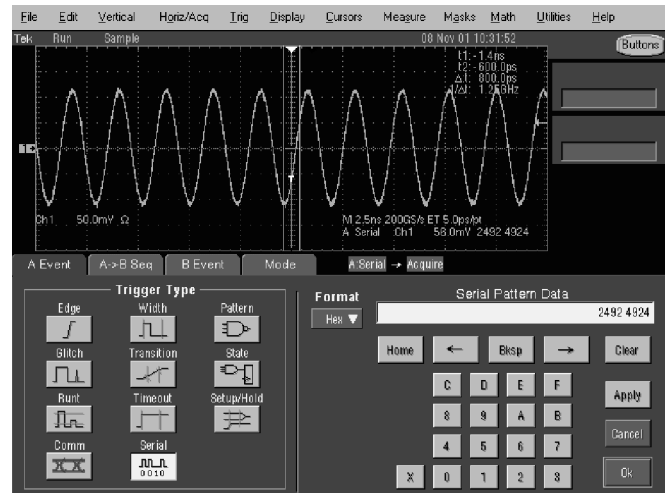

Triggered on a 1

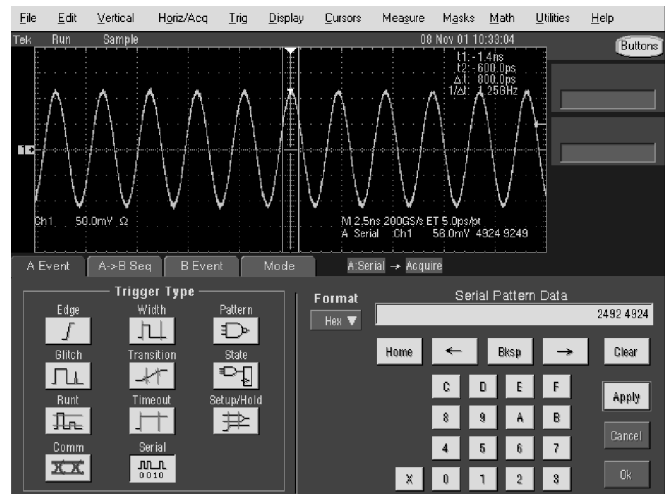

Triggered 1 UI after a 1

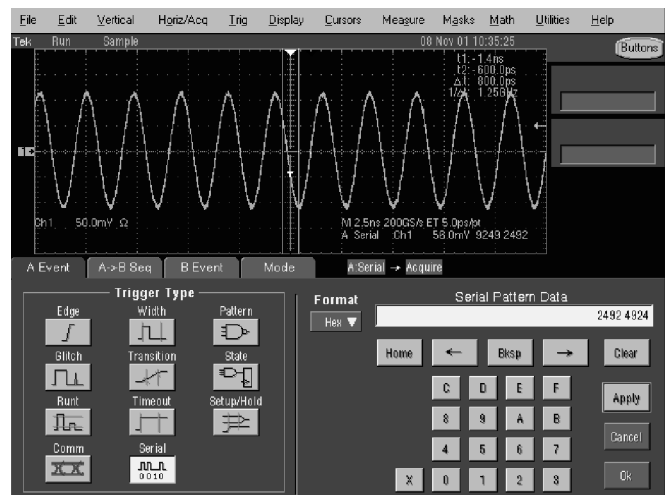
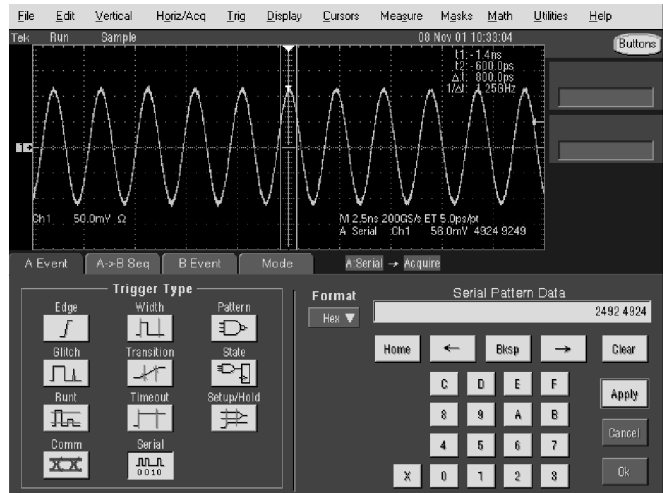

Figure 4-29: Isolated 1 triggering

- m. Verify that the instrument triggers one Unit Interval (UI) after the 1 in the input signal (see Figure 4-29). Enter pass or fail in the test record.
4. *Verify that the pattern matching circuits can do isolated 0:*
- a. Adjust the trigger **LEVEL** to trigger at 75% (+1 division) on the sine wave.
 - b. Set the Format to **Binary**, and then touch the **Clear** button.
 - c. Set the Serial Pattern Data pattern bits to XXXX XXXX XXXX XXXX XXXX XXXX XXXX XXX1₂.
 - d. Touch **Apply**.
 - e. Verify that the instrument triggers on a 1 (see Figure 4-30). Enter pass or fail in the test record.
 - f. Touch the **Clear** button.
 - g. Set all Serial Pattern Data bits to X except for the nth bit, where n is the step number.
 - h. Touch **Apply**.
 - i. Verify that the trigger occurs (n modulo 3) clock cycles after the 1 (see Figure 4-30). Enter pass or fail in the test record.
 - j. Repeat steps g through i until all 32 bits of the Serial Pattern Data have contained a 1.
5. *Disconnect the hookup:* Disconnect the cables and adapters from the inputs and outputs.

Triggering on a 1. Step 1, 4, 7, 10, ...



Triggering 1 clock cycle after a 1. Step 2, 5, 8, 11, ...

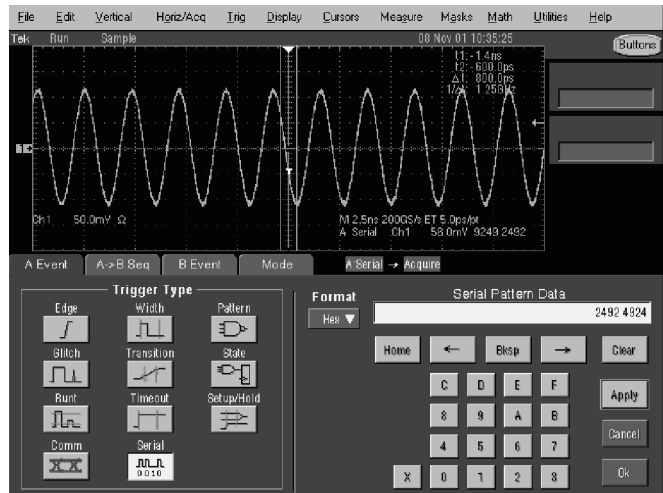

Triggering 2 clock cycles after a 1. Step 3, 6, 9, 12, ...

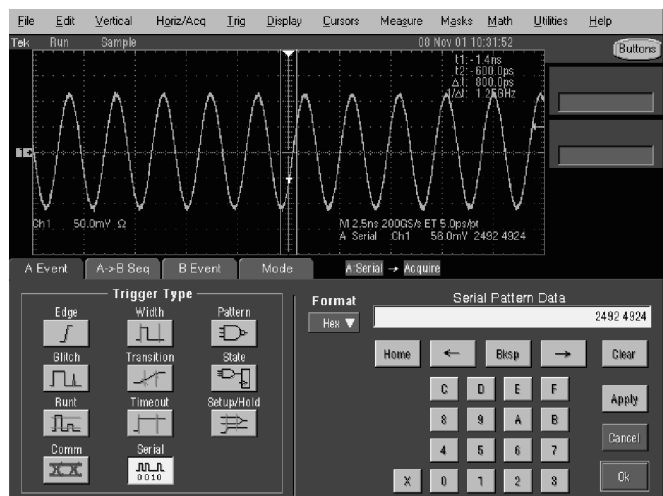
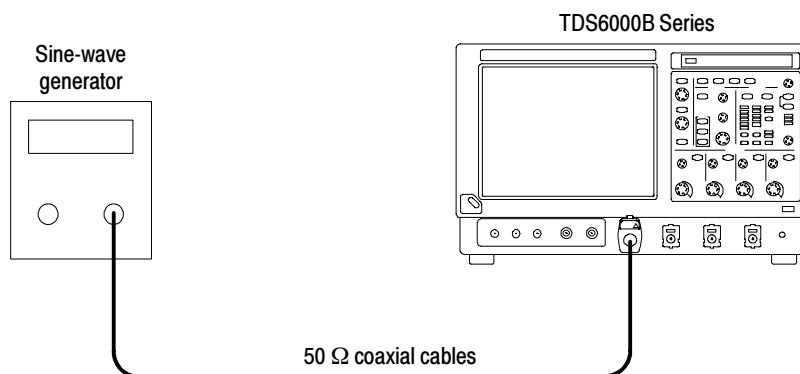

Figure 4-30: N modulo 3 triggering

Check Serial Trigger Clock Recovery Range

Equipment required	One precision 50 Ω coaxial cables (Item 4) One sine-wave generator (Item 12) One TCA-BNC or TCA-SMA adapter (item 20)
Prerequisites	See page 4-1. Also, the oscilloscope must have passed <i>Check DC Voltage Measurement Accuracy</i> on page 4-13.

1. Install the test hookup and preset the instrument controls:**Figure 4-31: Initial test hookup**

- a. *Hook up test-signal source 1 (See Figure 4-31):*
 - Connect the sine wave output of the sine-wave generator through a 50 Ω precision coaxial cable to CH 1 through an adapter.
 - Set the sine-wave generator to output a 1250 MHz sine wave.
- b. *Initialize the instrument:* Press the **DEFAULT SETUP** button.
- c. *Modify the initialized front-panel control settings:*
 - Press the Vertical **SCALE** to 50 mV per division.
 - Set the horizontal **SCALE** to 500 ps per division.
 - From the toolbar, touch the **Display** button.
 - Touch the Display Style to **Dots**.
 - Touch the Display Persistence to **Variable**, and set the Persist Time to **3.0 s**.
 - Touch the **Close** button.
 - Adjust the sine-wave generator output for 8 divisions of amplitude.

- From the toolbar, touch **Trig** and select the **A Event** tab.
- Touch the Select button.
- Touch the **Comm** button. Set **Source** to Ch1, **Type** to R Clk, and **Coding** to NRZ.

2. *Verify the clock recovery at frequency:*

- a. From the toolbar, touch **Trig** and select the **A Event** tab.
- b. Set the sine-wave generator to output one of the input frequencies in Table 4-10 (on page 4-70) that is not yet checked. (Start with the first setting listed.)
- c. Set the instrument Bit Rate to the Recovered clock Baud rate listed in the table for the current input frequency.

NOTE. *The instrument will attempt to acquire lock once. If the input data is disrupted, removed, or heavily distorted, the instrument may not acquire lock or may lose lock. If the recovered clock is not locked to the incoming data, the waveform display will not be stable (see Figure 4-32). Once the input data is available, press the PUSH SET TO 50% knob to force the instrument to acquire lock again.*

- d. Press **PUSH TO SET 50%**.

NOTE. *As the input frequency is lowered, adjust the Horizontal SCALE to maintain about 3 to 5 eyes across the display.*

- e. Verify that lock is acquired as in Figure 4-32, on page 4-72.
 - f. Repeat substeps b through d for each input frequency and Baud rate listed in Table 4-10.
 - g. If all tests pass, enter passed in the test record.
3. *Disconnect the hookup:* Disconnect the cables and adapters from the inputs and outputs.

Table 4-10: Clock recovery input frequencies and baud rates

Input frequency	Recovered clock Baud rate
1250 MHz	2500 Mbaud
625 MHz	2500 Mbaud
625 MHz	2375 Mbaud

Table 4-10: Clock recovery input frequencies and baud rates (Cont.)

Input frequency	Recovered clock Baud rate
594 MHz	2500 Mbaud
477.5 MHz	1950 Mbaud
462.5 MHz	1850 Mbaud
462.5 MHz	1757 Mbaud
439 MHz	1850 Mbaud
312.5 MHz	1250 Mbaud
310 MHz	1240 Mbaud
155 MHz	620 Mbaud
147 MHz	620 Mbaud
109 MHz,	462 Mbaud
115 MHz	439 Mbaud
77.5 MHz	310 Mbaud
39 MHz	156 Mbaud
19.5 MHz	78 Mbaud
9.75 MHz	39 Mbaud
4.875 MHz	19.5 Mbaud
2.438 MHz	9.75 Mbaud
1.219 MHz	4.876 Mbaud
609.5 kHz	2.438 Mbaud
304.8 kHz	1.219 Mbaud

Recovered clock locked
(1250 MHz)

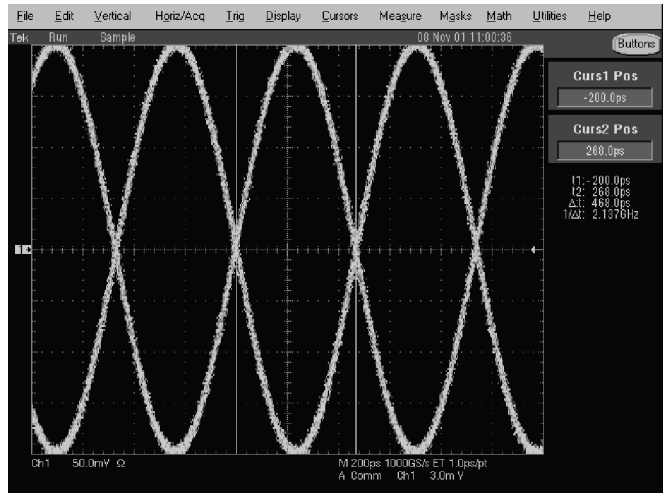

Recovered clock locked
(625 MHz through 304.8 kHz)

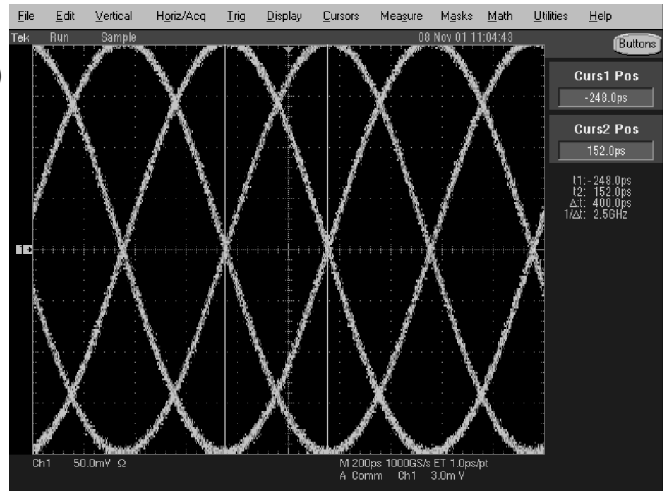

A possible display with the
recovered clock not locked

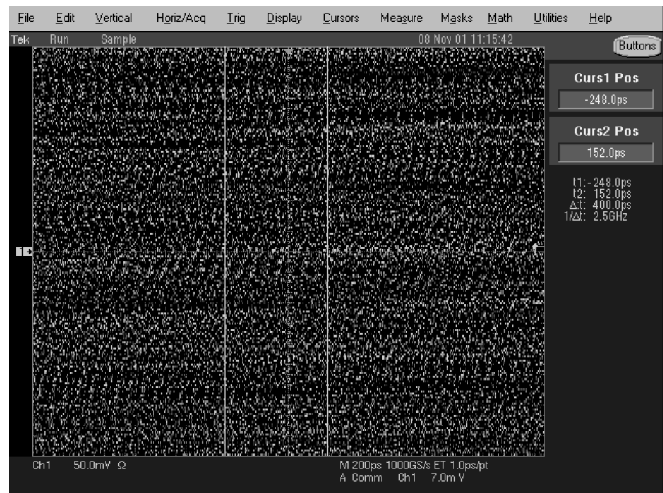

Figure 4-32: Clock recovery

Sine Wave Generator Leveling Procedure

Some procedures in this manual require a sine wave generator to produce the necessary test signals. If you do not have a leveled sine wave generator, use one of the following procedures to level the output amplitude of your sine wave generator.

Equipment required	Sine wave generator (Item 12) Level meter and power sensor (Item 13) Power splitter (Item 14) Two male N-to-female BNC adapters (Item 15) Two male N-to-female SMA adapters (Item 16) One precision coaxial cable (Item 4) One or two SMA male-to-female BNC adapter (Item 20)
Prerequisites	See page 4-1

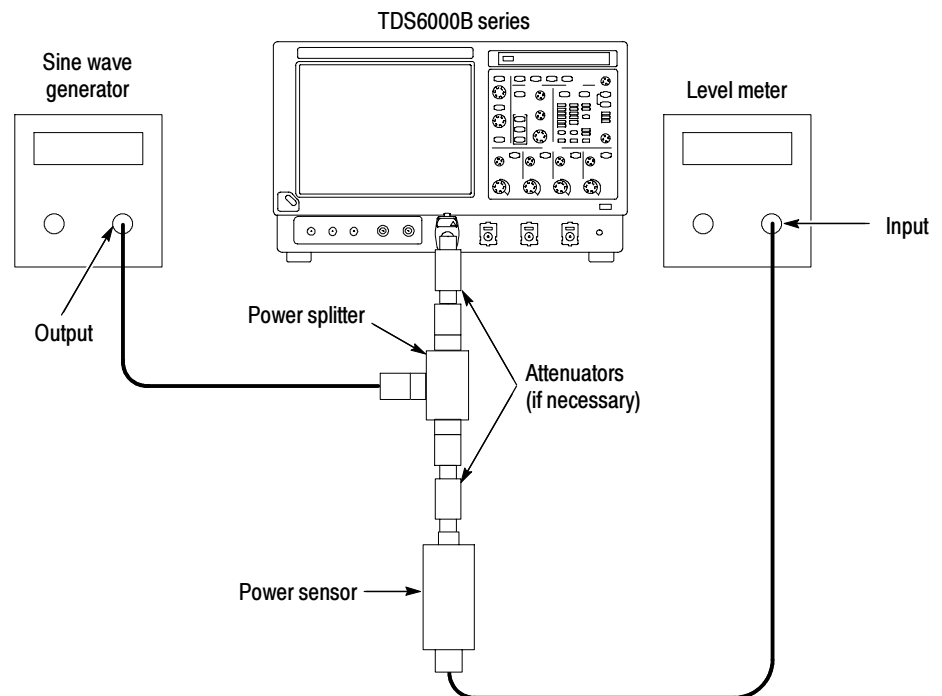

Figure 4-33: Sine wave generator leveling equipment setup

1. *Install the test hookup:* Connect the equipment as shown in Figure 4-33.

2. *Set the Generator:*

- Set the sine wave generator to a reference frequency of 10 MHz.
- Adjust the sine wave generator amplitude to the required number of divisions as measured by the oscilloscope.

3. *Record the reference level:* Note the reading on the level meter.

4. *Set the generator to the new frequency and reference level:*

- Change the sine wave generator to the desired new frequency.
- Input the correction factor and/or the new frequency into the level meter.
- Adjust the sine wave generator amplitude until the level meter again reads the value noted in step 3. The signal amplitude is now correctly set for the new frequency.

Equipment required	Sine wave generator (Item 12) Level meter and power sensor (Item 13) Two male N-to-female SMA adapters (Item 15) Two precision coaxial cables (Item 4) One or two SMA male-to-female BNC adapter (Item 20)
Prerequisites	See page 4-1

1. *Install the test hookup:* Connect the equipment as shown in Figure 4-34 (start with the sine wave generator connected to the oscilloscope).

2. *Set the Generator:*

- Set the sine wave generator to a reference frequency of 10 MHz.
- Adjust the sine wave generator amplitude to the required number of divisions as measured by the oscilloscope.

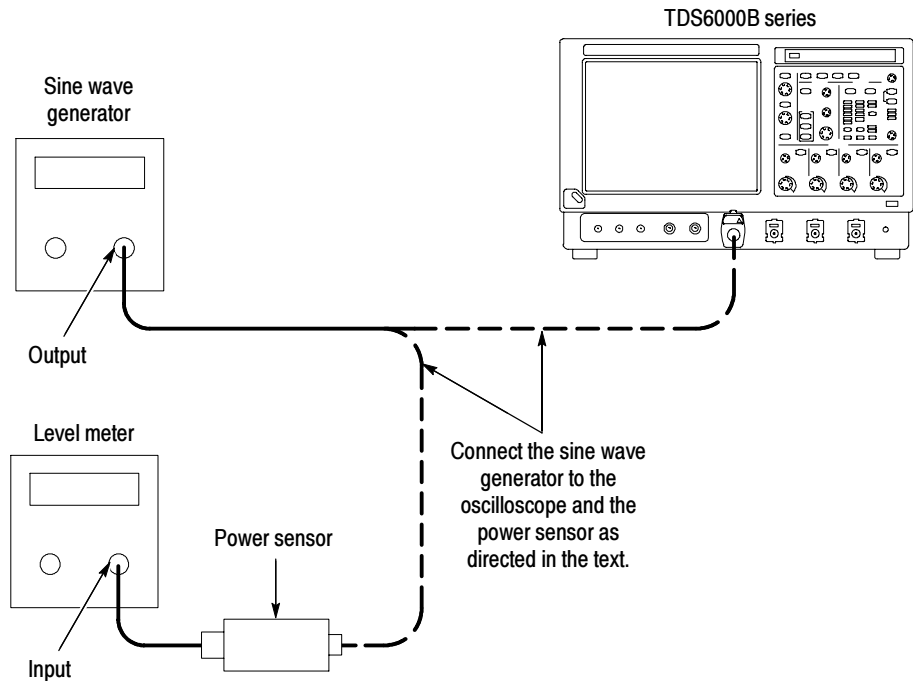

Figure 4-34: Equipment setup for maximum amplitude

3. Record the reference level:

- Disconnect the sine wave generator from the oscilloscope.
- Connect the sine wave generator to the power sensor.
- Note the level meter reading.

4. Set the generator to the new frequency and reference level:

- Change the sine wave generator to the desired new frequency.
- Input the correction factor and/or the new frequency into the level meter.
- Adjust the sine wave generator amplitude until the level meter again reads the value noted in step 3. The signal amplitude is now correctly set for the new frequency.
- Disconnect the sine wave generator from the power sensor.
- Connect the sine wave generator to the oscilloscope.

